

Multimedia Projector

SANYO

MODEL PLC-WXU30

Network Supported

- Wireless LAN
IEEE802.11b/g
- Wired LAN
100-Base-TX/10-Base-T

Memory Viewer

- SD Card Memory Viewer
 - *Refer to the owner's manuals below for details about network and memory viewer function.
- Network Set-up and Operation
- Memory viewer

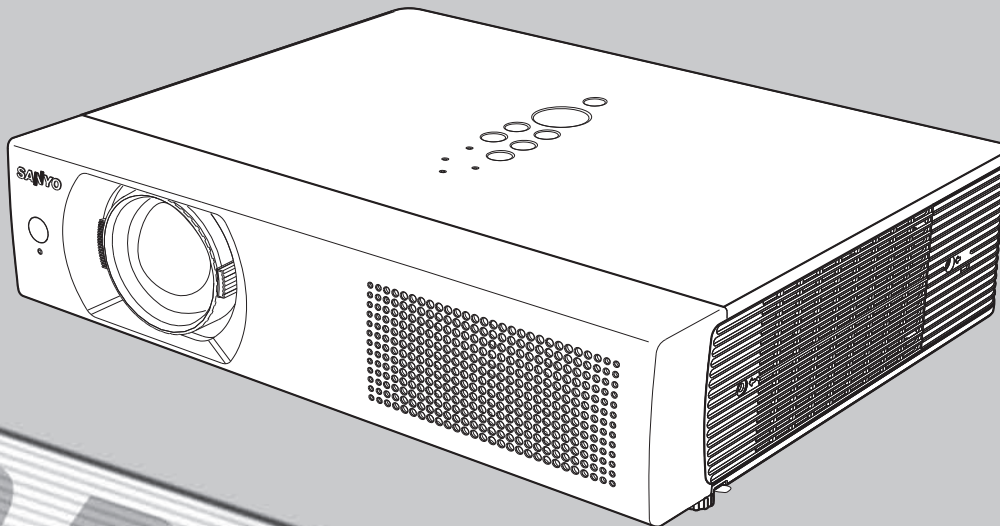

PROJECTOR

Owner's Manual

PJLink™

Features and Design

This Multimedia Projector is designed with the most advanced technology for portability, durability, and ease of use. This projector utilizes built-in multimedia features, a palette of 16.77 million colors, and matrix liquid crystal display (LCD) technology.

◆ **Compact Design**

This projector is designed compact in size and weight. It is easy to carry and installed anywhere you wish to use.

◆ **Capable of 360-degree Projection**

This projector is capable of 360-degree projection.
*Some restriction required, see page 8.

◆ **Antitheft Alarm Function**

This projector is equipped with an Antitheft alarm function which sounds when vibration is detected (pp.58–61). A built-in rechargeable battery is used for the alarm.

◆ **Simple Computer System Setting**

The projector has the Multi-scan system to conform to almost all computer output signals quickly (p.32). Up to UXGA resolution can be accepted.

◆ **Useful Functions for Presentations**

- The digital zoom function allows you to focus on the crucial information during a presentation (p.39).
- Blackboards* can be used as a projection screen.
*The board color is limited to Green (pp.36, 43).

◆ **Power Management**

The Power management function reduces power consumption and maintains the lamp life (p.52).

◆ **Lamp Control**

Brightness of the projection lamp can be selected (pp.28, 53).

◆ **Quick Termination**

The AC power cord can be unplugged immediately after turning off the projector without waiting for the termination of the cooling fan rotation (p.23).

◆ **Logo Function**

The Logo function allows you to customize the screen logo (pp.49–50). You can capture an image for the screen logo and use it for the starting-up display or between presentations.

◆ **Multilanguage Menu Display**

Operation menu is available in 16 languages; English, German, French, Italian, Spanish, Portuguese, Dutch, Swedish, Finnish, Polish, Hungarian, Romanian, Russian, Chinese, Korean, and Japanese (p.47).

◆ **Security Function**

The Security function helps you to ensure security of the projector. With the Key lock function, you can lock the operation on the top control or remote control (p.54). PIN code lock functions prevents unauthorized use of the projector (pp.22, 54–55).

◆ **Helpful Maintenance Functions**

Lamp and filter maintenance functions provide for better and proper maintenance of the projector.

◆ **LAN Network Function**

This projector is loaded with the Wired and Wireless LAN network function. You can project an image on a computer as well as operate and manage the projector via network. For details, refer to the owner's manual "Network Set-up and Operation."

◆ **Memory Viewer Function**

Insert the dedicated SD card memory into the projector to project images or presentation data stored within. You do not have to carry computers or other equipment for a presentation.

*SD card memory is not supplied with the projector. For details, refer to the owner's manual of Memory viewer.

◆ **Input Search Function**

Input signal can be searched automatically. (p.51)

✓ **Notes:**

- The On-Screen Menu and figures in this manual may differ slightly from the product.
- The contents of this manual are subject to change without notice.

Table of Contents

Features and Design	3	Input Source Selection (RGB(PC digital), RGB(AV HDCP))	31
Table of Contents	4	Computer System Selection	32
To the Owner	5	Auto PC Adjustment	33
Safety Instructions	6	Manual PC Adjustment	34
Air Circulation	7	Image Mode Selection	36
Moving the Projector	7	Image Adjustment	37
Installing the Projector in Proper Directions	8	Screen Size Adjustment	38
Compliance	9	For zooming in and out the images	39
Part Names and Functions	10	Video Input	40
Front	10	Input Source Selection (Video, S-video)	40
Back	10	Input Source Selection (Component, RGB Scart 21-pin)	41
Bottom	10	Video System Selection	42
Rear Terminal	11	Image Mode Selection	43
Top Control	12	Image Adjustment	44
Remote Control	13	Screen Size Adjustment	46
Laser Pointer Function	14	Setting	47
Pointer Function	14	Setting	47
Wireless Mouse Operation	15	Antitheft Alarm Function	58
Remote Control Code	15	How to use Antitheft Alarm Function	58
Remote Control Battery Installation	16	Maintenance and Cleaning	62
Remote Control Operating Range	16	Warning Indicator	62
Adjustable Feet	16	Cleaning the Filter	63
Installation	17	Resetting the Filter Counter	63
Positioning the Projector	17	Attaching the Lens Cover	64
Connecting the AC Power Cord	18	Cleaning the Projection Lens	64
Connecting to a Computer	19	Cleaning the Projector Cabinet	64
Connecting to Video Equipment	20	Lamp Replacement	65
Connecting to Component Video Equipment	21	Resetting the Lamp Counter	66
Basic Operation	22	Appendix	67
Turning On the Projector	22	Troubleshooting	67
Turning Off the Projector	23	Menu Tree	71
How to Operate the On-Screen Menu	24	Indicators and Projector Condition	73
Menu Bar	25	Compatible Computer Specifications	74
Zoom and Focus Adjustment	26	Technical Specifications	76
Auto Setup Function	26	Optional Parts	77
Keystone Correction	26	PJ Link Notice	78
Sound Adjustment	27	Configurations of Terminals	79
Remote Control Operation	28	PIN Code Number Memo	80
Computer Input	30	Lamp Replacement Label	80
Input Source Selection (RGB: Computer 1 (Analog)/Computer 2)	30	Dimensions	81

Trademarks

Each name of corporations or products in this book is either a registered trademark or a trademark of its respective corporation.





To the Owner

Before installing and operating this projector, read this manual thoroughly.

This projector provides many convenient features and functions. Operating the projector properly enables you to manage those features and maintains it in good condition for many years to come.

Improper operation may result in not only shortening the product-life, but also malfunctions, fire hazard, or other accidents.

If your projector seems to operate improperly, read this manual again, check operations and cable connections and try the solutions in the "Troubleshooting" section in the back of this booklet. If the problem still persists, contact the dealer where you purchased the projector or the service center.

	CAUTION RISK OF ELECTRIC SHOCK DO NOT OPEN	
CAUTION: TO REDUCE THE RISK OF ELECTRIC SHOCK, DO NOT REMOVE COVER (OR BACK). NO USER-SERVICEABLE PARTS INSIDE EXCEPT LAMP REPLACEMENT. REFER SERVICING TO QUALIFIED SERVICE PERSONNEL.		
	THIS SYMBOL INDICATES THAT DANGEROUS VOLTAGE CONSTITUTING A RISK OF ELECTRIC SHOCK IS PRESENT WITHIN THIS UNIT.	
	THIS SYMBOL INDICATES THAT THERE ARE IMPORTANT OPERATING AND MAINTENANCE INSTRUCTIONS IN THE OWNER'S MANUAL WITH THIS UNIT.	

NOTE: This symbol and recycle system are applied to EU countries only and not applied to the countries in the other area of the world.



Your SANYO product is designed and manufactured with high quality materials and components which can be recycled and reused.

This symbol means that electrical and electronic equipment, at their end-of-life, should be disposed of separately from your household waste.

Please dispose of this equipment at your local community waste collection/recycling centre. In the European Union there are separate collection systems for used electrical and electronic products.

Please help us to conserve the environment we live in!

READ AND KEEP THIS OWNER'S MANUAL FOR LATER USE.



Safety Precaution

WARNING: TO REDUCE THE RISK OF FIRE OR ELECTRIC SHOCK, DO NOT EXPOSE THIS APPLIANCE TO RAIN OR MOISTURE.

- This projector produces intense light from the projection lens. Do not stare directly into the lens, otherwise eye damage could result. Be especially careful that children do not stare directly into the beam.
- Install the projector in a proper position. Otherwise it may result in fire hazard.
- Allowing the proper amount of space on the top, sides, and rear of the projector cabinet is critical for proper air circulation and cooling of the unit. The dimension shown here indicate the minimum space required. If the projector is to be built into a compartment or similarly enclosed, these minimum distances must be maintained.

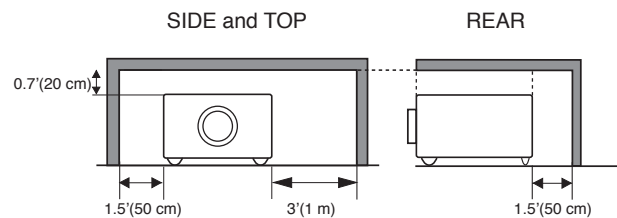

- Do not cover the ventilation slot on the projector. Heat build-up can reduce the service life of your projector, and can also be dangerous.
- If the projector is unused for an extended time, unplug the projector from the power outlet.



CAUTION

DO NOT SET THE PROJECTOR IN GREASY, WET, OR SMOKY CONDITIONS SUCH AS IN A KITCHEN TO PREVENT A BREAKDOWN OR A DISASTER. IF THE PROJECTOR COMES IN CONTACT WITH OIL OR CHEMICALS, IT MAY BECOME DETERIORATED.

CAUTION

Not for use in a computer room as defined in the Standard for the Protection of Electronic Computer/Data Processing Equipment, ANSI/NFPA 75.

Ne peut être utilisé dans une salle d'ordinateurs telle que définie dans la norme ANSI/NFPA 75 Standard for Protection of Electronic Computer/Data Processing Equipment.

Safety Instructions

All the safety and operating instructions should be read before the product is operated.

Read all of the instructions given here and retain them for later use. Unplug this projector from AC power supply before cleaning. Do not use liquid or aerosol cleaners. Use a damp cloth for cleaning.

Follow all warnings and instructions marked on the projector.

For added protection to the projector during a lightning storm, or when it is left unattended and unused for long periods of time, unplug it from the wall outlet. This will prevent damage due to lightning and power line surges.

Do not expose this unit to rain or use near water... for example, in a wet basement, near a swimming pool, etc...

Do not use attachments not recommended by the manufacturer as they may cause hazards.

Do not place this projector on an unstable cart, stand, or table. The projector may fall, causing serious injury to a child or adult, and serious damage to the projector. Use only with a cart or stand recommended by the manufacturer, or sold with the projector. Wall or shelf mounting should follow the manufacturer's instructions, and should use a mounting kit approved by the manufacturers.

An appliance and cart combination should be moved with care. Quick stops, excessive force, and uneven surfaces may cause the appliance and cart combination to overturn.



Slots and openings in the back and bottom of the cabinet are provided for ventilation, to ensure reliable operation of the equipment and to protect it from overheating.

The openings should never be covered with cloth or other materials, and the bottom opening should not be blocked by placing the projector on a bed, sofa, rug, or other similar surface. This projector should never be placed near or over a radiator or heat register.

This projector should not be placed in a built-in installation such as a book case unless proper ventilation is provided.

Never push objects of any kind into this projector through cabinet slots as they may touch dangerous voltage points or short out parts that could result in a fire or electric shock. Never spill liquid of any kind on the projector.

Do not install the projector near the ventilation duct of air-conditioning equipment.

This projector should be operated only from the type of power source indicated on the marking label. If you are not sure of the type of power supplied, consult your authorized dealer or local power company.

Do not overload wall outlets and extension cords as this can result in fire or electric shock. Do not allow anything to rest on the power cord. Do not locate this projector where the cord may be damaged by persons walking on it.

Do not attempt to service this projector yourself as opening or removing covers may expose you to dangerous voltage or other hazards. Refer all servicing to qualified service personnel.

Unplug this projector from wall outlet and refer servicing to qualified service personnel under the following conditions:

- a. When the power cord or plug is damaged or frayed.
- b. If liquid has been spilled into the projector.
- c. If the projector has been exposed to rain or water.
- d. If the projector does not operate normally by following the operating instructions. Adjust only those controls that are covered by the operating instructions as improper adjustment of other controls may result in damage and will often require extensive work by a qualified technician to restore the projector to normal operation.
- e. If the projector has been dropped or the cabinet has been damaged.
- f. When the projector exhibits a distinct change in performance-this indicates a need for service.

When replacement parts are required, be sure the service technician has used replacement parts specified by the manufacturer that have the same characteristics as the original part. Unauthorized substitutions may result in fire, electric shock, or injury to persons.

Upon completion of any service or repairs to this projector, ask the service technician to perform routine safety checks to determine that the projector is in safe operating condition.

Air Circulation

Openings in the cabinet are provided for ventilation. To ensure reliable operation of the product and to protect it from overheating, these openings must not be blocked or covered.



CAUTION

Hot air is exhausted from the exhaust vent. When using or installing the projector, the following precautions should be taken.

- Do not put any flammable object or spray can near the projector, hot air is exhausted from the air vents.
- Keep the exhaust vent at least 3' (1 m) away from any objects.
- Do not touch a peripheral part of the exhaust vent, especially screws and metallic parts. These areas will become hot while the projector is being used.
- Do not put anything on the cabinet. Objects put on the cabinet will not only get damaged but also may cause fire hazard by heat.

Cooling fans are provided to cool down the projector. The fans' running speed is changed according to the temperature inside the projector.

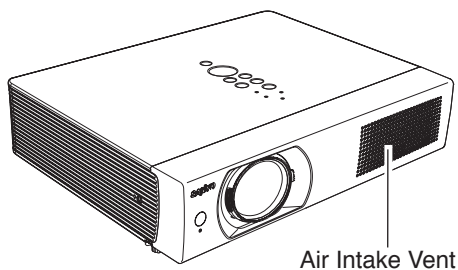

Air Intake Vent

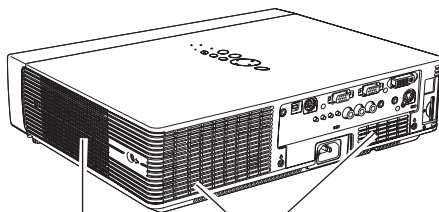

Exhaust Vent
(Hot air exhaust)

Air Intake Vent

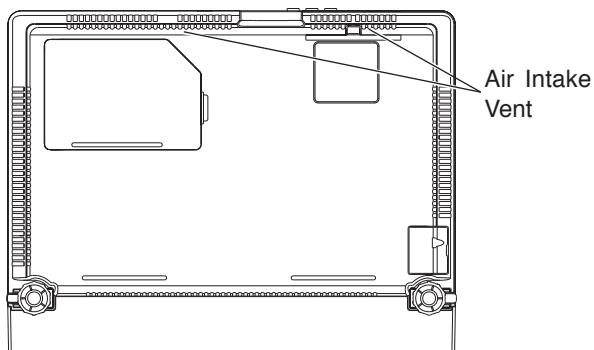

Air Intake
Vent

Moving the Projector

When moving the projector, replace the lens cover and retract adjustable feet to prevent damage to the lens and cabinet.

When the projector is not in use for an extended period, put it into the supplied carrying case with the lens side up.



CAUTION

The carrying case (supplied) is intended for protection against dust and scratches on surface of the cabinet, and it is not designed to protect an appliance from external forces. Do not transport the projector by courier or any other transport service with this case, otherwise the projector can be damaged. When handling the projector, do not drop, bump, subject it to strong forces, or put other things on the cabinet.



CAUTION IN CARRYING OR TRANSPORTING THE PROJECTOR

- Do not drop or bump the projector, otherwise damages or malfunctions may result.
- When carrying the projector, use a suitable carrying case.
- Do not transport the projector by courier or any other transport service in an unsuitable transport case. This may cause damage to the projector. For information about transporting the projector by courier or any other transport service, consult your dealer.
- Do not put the projector in a case before the projector is cooled enough.

Safety Instructions

Installing the Projector in Proper Directions

Use the projector properly in specified positions. Improper positioning may reduce the lamp life and result in severe accident or fire hazard.

This projector can project the picture upward, downward, or backward, perpendicular to the plane of the screen as shown in the figure below.

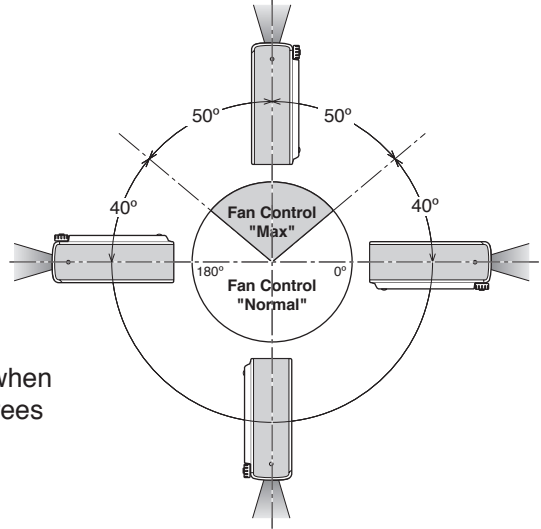
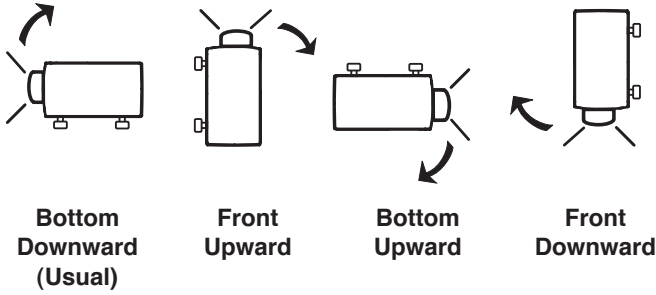

Be sure to set the Fan control in MAX in the setting menu when the projector is inclined between +40 degrees to +140 degrees to the horizontal plane (p.56).

Positioning Precautions

Avoid positioning the projector as described below when installing.

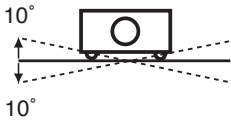

Do not tilt the projector more than 10 degrees from side to side.



Do not put the projector on either side to project an image.

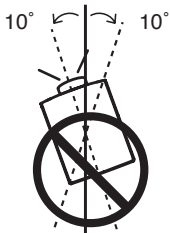

In upward projection, do not tilt the projector over 10 degrees right and left.

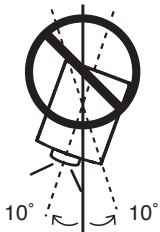

In downward projection, do not tilt the projector over 10 degrees right and left.

Compliance

Federal Communications Commission Notice

Note: This equipment has been tested and found to comply with the limits for a Class B digital device, pursuant to Part 15 of the FCC Rules. These limits are designed to provide reasonable protection against harmful interference in a residential installation. This equipment generates, uses, and can radiate radio frequency energy, and if not installed and used in accordance with the instructions, may cause harmful interference to radio communications. However, there is no guarantee that interference will not occur in a particular installation. If this equipment does cause harmful interference to radio or television reception, which can be determined by turning the equipment off and on, the user is encouraged to try to correct the interference by one or more of the following measures:

- Reorient or relocate the receiving antenna.
- Increase the separation between the equipment and receiver.
- Connect the equipment into an outlet on a circuit different from that to which the receiver is connected.
- Consult the dealer or an experienced radio/TV technician for help.

Use of shielded cable is required to comply with class B limits in Subpart B of Part 15 of FCC Rules.

Do not make any changes or modifications to the equipment unless otherwise specified in the instructions. If such changes or modifications should be made, you could be required to stop operation of the equipment.

Model Number : PLC-WXU30
Trade Name : Sanyo
Responsible party : SANYO FISHER COMPANY
Address : 21605 Plummer Street, Chatsworth, California 91311
Telephone No. : (818)998-7322

AC Power Cord Requirement

The AC Power Cord supplied with this projector meets the requirement for use in the country you purchased it.

AC Power Cord for the United States and Canada:

AC Power Cord used in the United States and Canada is listed by the Underwriters Laboratories (UL) and certified by the Canadian Standard Association (CSA).

AC Power Cord has a grounding-type AC line plug. This is a safety feature to be sure that the plug will fit into the power outlet. Do not try to defeat this safety feature. Should you be unable to insert the plug into the outlet, contact your electrician.



AC Power Cord for the United Kingdom:

This cord is already fitted with a moulded plug incorporating a fuse, the value of which is indicated on the pin face of the plug. Should the fuse need to be replaced, an ASTA approved BS 1362 fuse must be used of the same rating, marked thus \diamond . If the fuse cover is detachable, never use the plug with the cover omitted. If a replacement fuse cover is required, ensure it is of the same colour as that visible on the pin face of the plug (i.e. red or orange). Fuse covers are available from the Parts Department indicated in your User Instructions.

If the plug supplied is not suitable for your socket outlet, it should be cut off and destroyed.

The end of the flexible cord should be suitably prepared and the correct plug fitted.

WARNING : A PLUG WITH BARED FLEXIBLE CORD IS HAZARDOUS IF ENGAGED IN A LIVE SOCKET OUTLET.

The Wires in this mains lead are coloured in accordance with the following code:

- Green-and-yellow Earth
- Blue Neutral
- Brown Live

As the colours of the wires in the mains lead of this apparatus may not correspond with the coloured markings identifying the terminals in your plug proceed as follows:

The wire which is coloured green-and-yellow must be connected to the terminal in the plug which is marked by the letter E or by the safety earth symbol \perp or coloured green or green-and-yellow.

The wire which is coloured blue must be connected to the terminal which is marked with the letter N or coloured black.

The wire which is coloured brown must be connected to the terminal which is marked with the letter L or coloured red.

WARNING: THIS APPARATUS MUST BE EARTHED.

THE SOCKET-OUTLET SHOULD BE INSTALLED NEAR THE EQUIPMENT AND EASILY ACCESSIBLE.

Part Names and Functions

Front

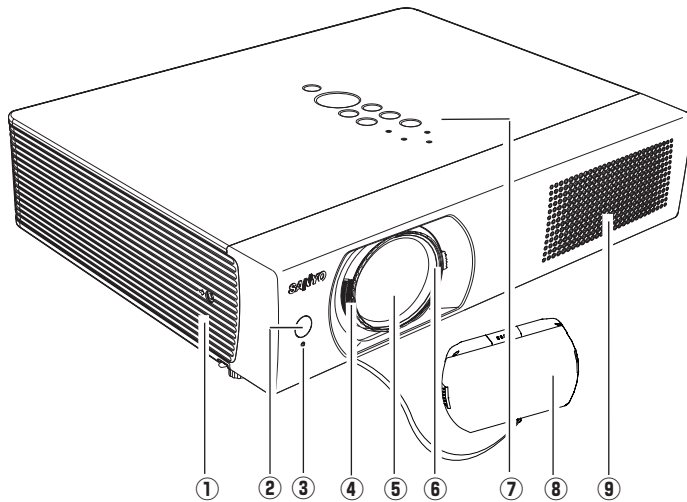

- ① Alarm Speaker
- ② Infrared Remote Receiver
- ③ WIRELESS Indicator
- ④ Focus Lever
- ⑤ Projection Lens
- ⑥ Zoom Ring
- ⑦ Top Controls and Indicators
- ⑧ Lens Cover

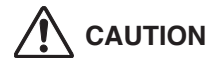

Do not turn on a projector with lens cap attached. High temperature from light beam may damage lens cap and result in fire hazard.

Back

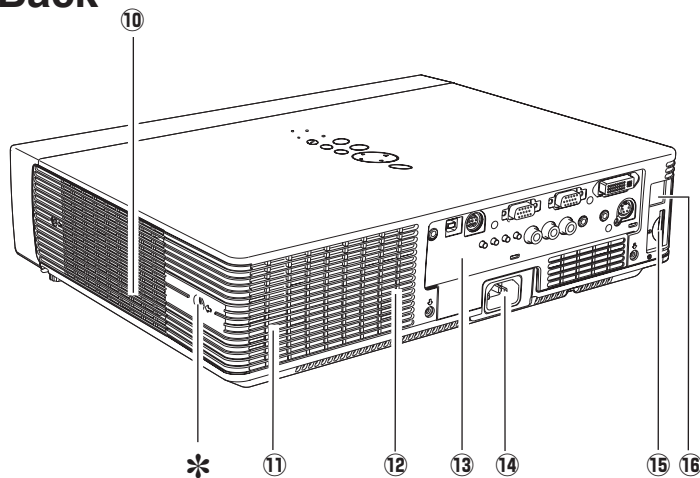

- ⑨ Air Intake Vent

- ⑩ Exhaust vent

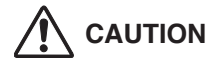

Hot air is exhausted from the exhaust vents. Do not put heat-sensitive objects near this side.

- ⑪ Speaker
- ⑫ Air Intake Vent (back and bottom)
- ⑬ Terminals and Connectors
- ⑭ Power Cord Connector
- ⑮ SD Card Slot
- ⑯ LAN Connection Terminal

Bottom

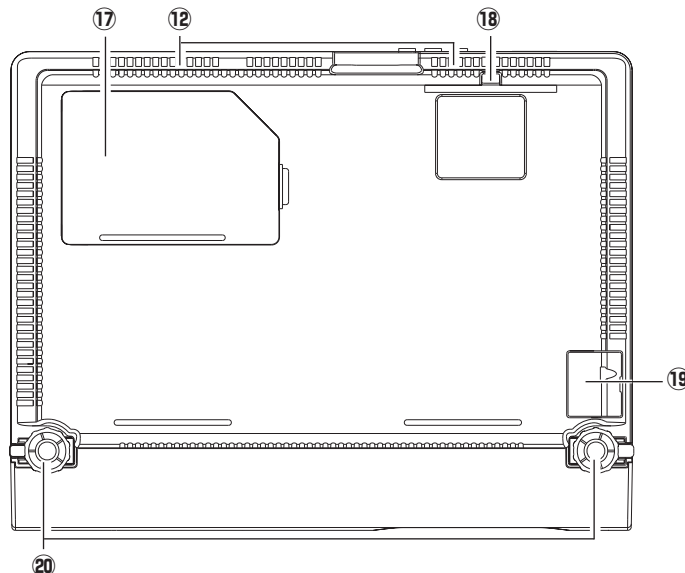

- ⑰ Lamp Cover
- ⑱ Filter
- ⑲ Battery Cover
- ⑳ Adjustable Feet

✓ Note:

③ WIRELESS Indicator and ⑯ LAN Connection Terminal are for the Network function. Refer to the owner's manual "Network Set-up and Operation".

* Kensington Security Slot

This slot is for a Kensington lock used to deter theft of the projector.

* Kensington is a registered trademark of ACCO Brands Corporation.

Rear Terminal

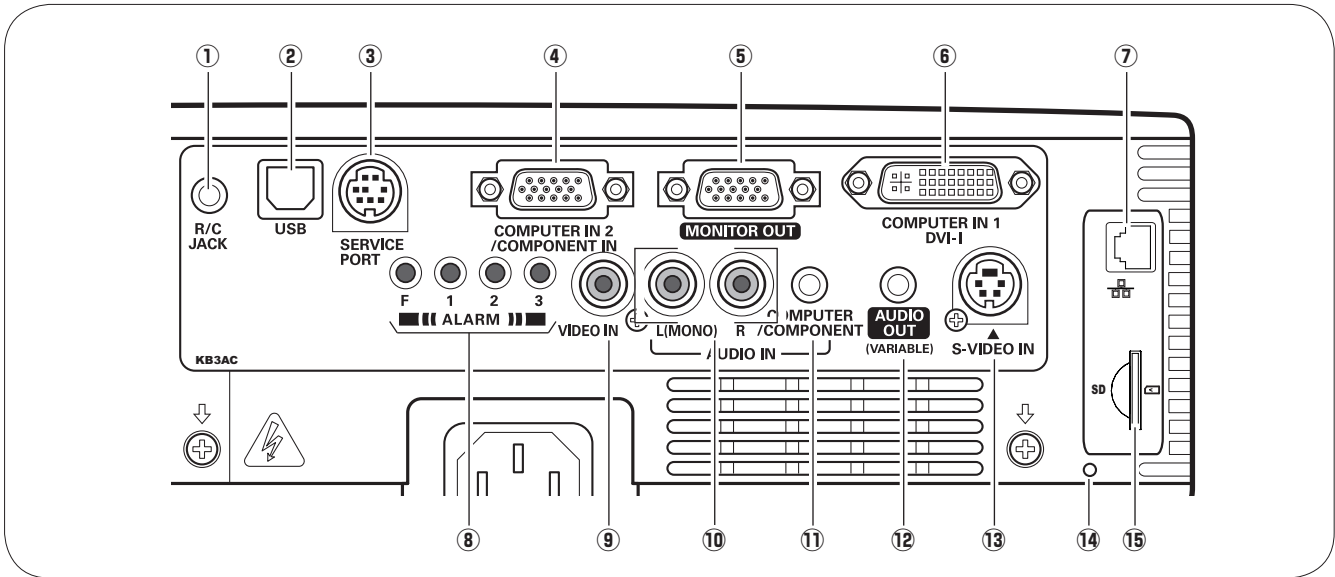

- ① R/C JACK**
When using the wired remote control, connect the wired remote control to this jack with a remote control cable (not supplied).
- ② USB (Series B)**
In order to operate the computer with the remote control and use the PAGE ▲▼ buttons on the remote control during a presentation, connect the USB port of the computer to the USB terminal with a USB cable (not supplied) (pp.13, 19).
- ③ SERVICE PORT**
This jack is used to service the projector.
- ④ COMPUTER IN 2/COMPONENT IN**
Connect the computer or component video (or RGB Scart) output signal to this terminal (pp.19, 21). Use the supplied VGA cable or a Component-VGA cable commercially available.
- ⑤ MONITOR OUT**
This terminal can be used to output the incoming RGB analog signal from COMPUTER IN 1 and COMPUTER IN 2/COMPONENT IN terminal to the other monitor (p.19).
- ⑥ COMPUTER IN 1/DVI-I**
Connect computer output (Digital/Analog DVI-I type) to this terminal (p.19).
- ⑦ LAN Connection Terminal**
Connect the LAN cable (refer to the owner's manual "Network Set-up and Operation").
- ⑧ ALARM buttons**
Use these buttons when setting up the Alarm function (pp.58–59).
- ⑨ VIDEO IN**
Connect the composite video output signal to this jack (p.20).
- ⑩ AUDIO IN**
Connect the audio output signal from video equipment connected to ⑨ or ⑬ to this jack. For a mono audio signal (a single audio jack), connect it to the L (MONO) jack (p.20).
- ⑪ COMPUTER/COMPONENT AUDIO IN**
Connect the audio output (stereo) signal from a computer or video equipment connected to ④ or ⑥ to this jack (pp.19, 21).
- ⑫ AUDIO OUT (VARIABLE)**
Connect an external audio amplifier to this jack (pp.19–21). This terminal outputs sound from AUDIO IN terminal (⑩ or ⑪).
- ⑬ S-VIDEO IN**
Connect the S-VIDEO output signal from video equipment to this jack (p.20).
- ⑭ SD Card Indicator**
Display the status of SD card. When inserting SD Card, the indicator lights, and when removing SD Card, the indicator turns off.
- ⑮ SD Card Slot**
Insert the SD card memory (not supplied) for Memory viewer operation (refer to the owner's manual of Memory viewer).

Top Control

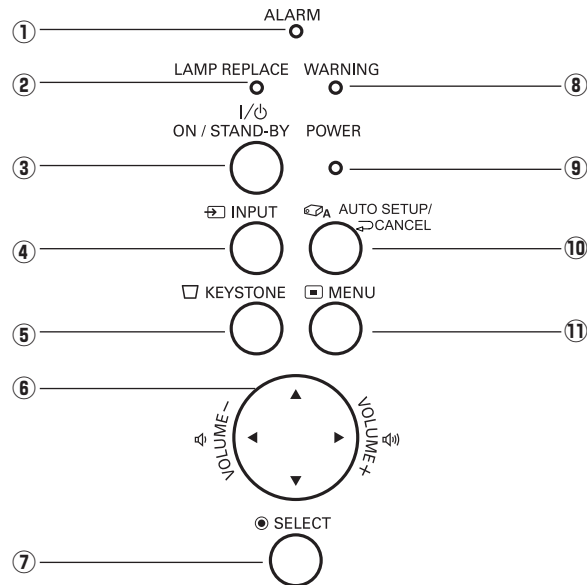

① ALARM indicator

Blinks red when informing the setting or battery status (pp.58–59).

② LAMP REPLACE indicator

Lights yellow when the projection lamp reaches its end of life (pp.65, 71).

③ ON/STAND-BY button

Turn the projector on or off (pp.22–23).

④ INPUT button

Select an input source (pp.30–31, 40–41).

⑤ KEystone button

Correct keystone distortion (pp.26, 48).

⑥ POINT ▲▼◀▶ (VOLUME +/-) buttons

- Select an item or adjust the value in the On-Screen Menu (p.24).
- Pan the image in the Digital zoom + mode (p.39).
- Adjust the volume level (Point ◀▶ buttons) (p.27).

⑦ SELECT button

- Execute the selected item (p.24).
- Expand or compress the image in the Digital zoom mode (p.39).

⑧ WARNING indicator

- Lights red when the projector detects an abnormal condition.
- Blinks red when the internal temperature of the projector exceeds the operating range (pp.62, 71).

⑨ POWER indicator

- Lights red when the projector is in stand-by mode.
- Lights green during operations.
- Blinks green in the Power management mode (p.52).

⑩ AUTO SETUP/CANCEL button

- Correct vertical keystone distortion and adjust computer display parameters such as Fine sync., Total dots, and Picture position (pp.26, 47).
- Display the image in SD card or return to the menu bar in Memory Viewer menu. Refer to the owner's manual of "Network Set-up and Operation" and owner's manual of Memory viewer.

⑪ MENU button

Open or close the On-Screen Menu (p.24).

Remote Control

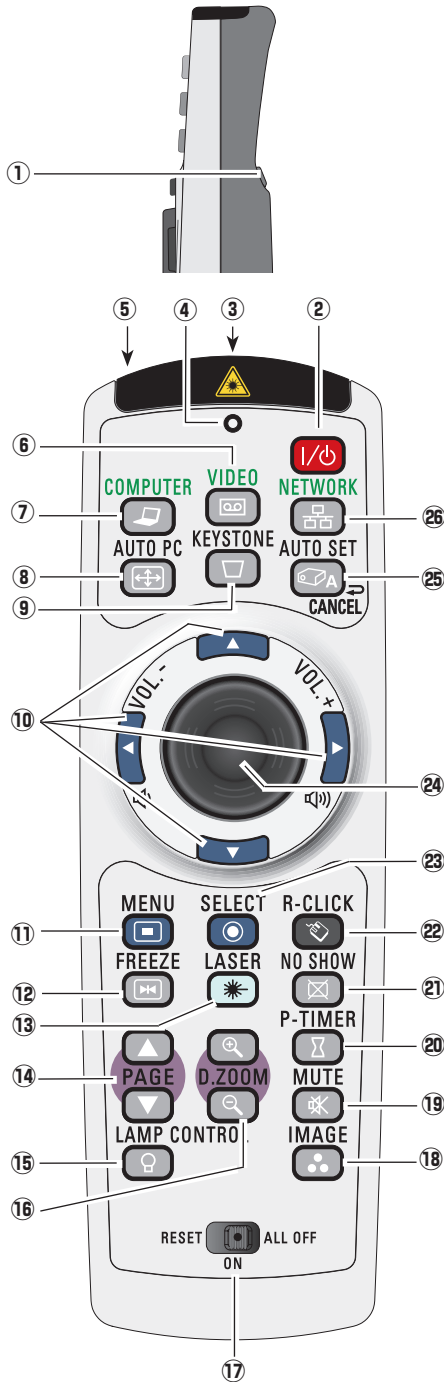

- ① **L-CLICK button**
Act as the left mouse button for wireless mouse operation. (p.15)
- ② **POWER ON/STAND-BY button**
Turn the projector on or off. (pp.22-23)
- ③ **WIRED REMOTE jack**
Connect the remote control cable(not supplied) to this jack when using as a wired remote control.Wireless remote control does not work when the remote control cable is connected to the projector
- ④ **SIGNAL EMISSION indicator**
Lights red while the laser beam is being emitted from the laser light window or a signal is being sent from the remote control to the projector.
- ⑤ **LASER LIGHT window**
A laser beam is emitted from here (p.14).
- ⑥ **VIDEO button**
Select the VIDEO input source. (p.40)
- ⑦ **COMPUTER button**
Select the COMPUTER input source. (pp.30-31,41)
- ⑧ **AUTO PC button**
Automatically adjust the computer image to its optimum setting. (pp.28,33,47)
- ⑨ **KEYSTONE button**
Correct keystone distortion. (pp.26, 48)
- ⑩ **Point ▲▼◀▶ (VOLUME +/-) buttons**
– Select an item or adjust the value in the On-Screen Menu. (p.24)
– Pan the image in the Digital zoom + mode. (p.39)
– Adjust the volume level. (Point ◀▶ buttons) (p.27)
- ⑪ **MENU button**
Open or close the On-Screen Menu. (p.24)
- ⑫ **FREEZE button**
Freeze the picture on the screen. (p.28)
- ⑬ **LASER button**
– Operate the Laser pointer function. Laser beam is emitted while pressing this button within 1 minute. When using this laser pointer for more than 1 minute, release the LASER button and press it again. (p.14)
– Display the Pointer on the screen. (p.14)
- ⑭ **PAGE ▲▼ buttons**
Scroll back and forth the pages on the screen when giving a presentation. To use these buttons, connect the projector and your computer with a USB cable. (pp.11, 19)
- ⑮ **LAMP CONTROL button**
Select a lamp mode. (pp.28, 53)
- ⑯ **D.ZOOM ▲▼ buttons**
Zoom in and out the images. (pp.28, 39)
- ⑰ **RESET/ON/ALL-OFF switch**
When using the remote control, set this switch to "ON." Set it to "ALL OFF" for power saving when it is not used. Slide this switch to "RESET" to initialize the remote control code or switch Spotlight and Pointer to the Laser pointer function. (pp.14-15)
- ⑱ **IMAGE button**
Select the image mode. (pp.29,36,43)
- ⑲ **MUTE button**
Mute the sound. (p.27)
- ⑳ **P-TIMER button**
Operate the P-timer function. (p.29)
- ㉑ **NO SHOW button**
Temporarily turn off the image on the screen. (p.29)
- ㉒ **R-CLICK button**
Act as the right mouse button for wireless mouse operation. (p.15)
- ㉓ **SELECT button**
– Execute the selected item. (p.24)
– Expand or compress the image in Digital zoom mode. (p.39)
- ㉔ **PRESENTATION POINTER button**
Move a pointer of the projector or a pointer for wireless mouse operation. (pp.14-15)
- ㉕ **AUTO SET/CANCEL button**
– Correct vertical keystone distortion and adjust the PC display parameters. (pp.26, 47)
– Display the image in SD card or return to the menu bar in Memory Viewer menu. Refer to the owner's manual of "Network Set-up and Operation" and owner's manual of Memory viewer.
- ㉖ **NETWORK button**
Select the Network input or Memory viewer input. See owner's manual "Network Set-up and Operation" and owner's manual of Memory viewer .



To ensure safe operation, please observe the following precautions:

- Do not bend, drop, or expose the remote control to moisture or heat.
- For cleaning, use a soft dry cloth. Do not apply benzene, thinner, splay, or any chemical material.

Part Names and Functions

Laser Pointer Function

This remote control emits a laser beam from the laser light window. Press the LASER button to activate the laser pointer. The signal emission indicator lights red and the red laser beam is emitted. If the LASER button is pressed for more than one minute or if it is released, the laser light goes off.

The laser emitted is a Class II laser. Do not look into the laser light window or point the laser beam at yourself or other people. The following is the caution label for the laser beam.

CAUTION: Use of controls, adjustments or performance of procedures other than those specified herein may result in hazardous radiation exposure. Never look directly into the laser light window while a laser is emitted, otherwise eye damage may result.

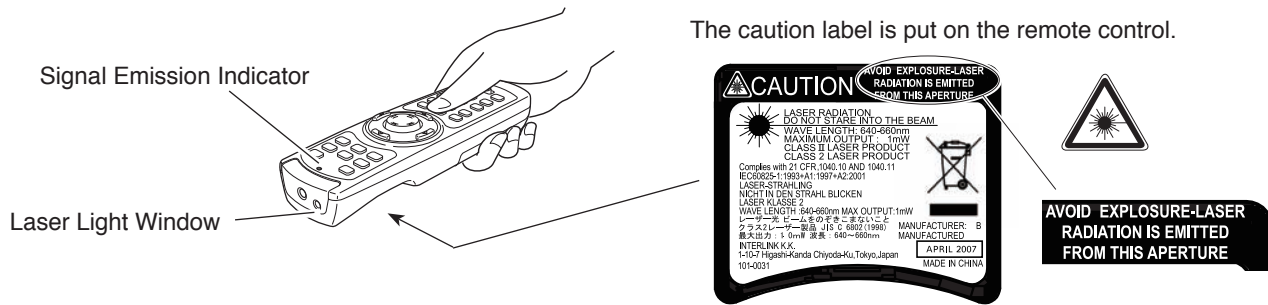

The caution label is put on the remote control.

Pointer Function

You can move the Spotlight or Pointer of the projector with the remote control to emphasize a part of the projected image.

- 1 Press and hold the MENU and NO SHOW buttons for more than 10 seconds to activate the Pointer function. (The Laser pointer has switched to the Pointer function.)
- 2 Press the LASER button on the remote control pointing toward the projector. The Spotlight or Pointer is displayed on the screen with the LASER button lighting green. Then move the Spotlight or Pointer with the PRESENTATION POINTER button. If the LASER button does not light green and continues to emit a laser beam, try the abovementioned procedure until the LASER button lights green.
- 3 To clear the Spotlight or Pointer out the screen, press the LASER button pointing toward the projector and see if the LASER button lighting is turned off. To switch to the Laser pointer again, press and hold the NO SHOW and MENU buttons for more than 10 seconds or slide the RESET/ON/ALL-OFF switch to "RESET" and then to "ON". When you reset the Pointer function, the remote control code will be reset, as well.

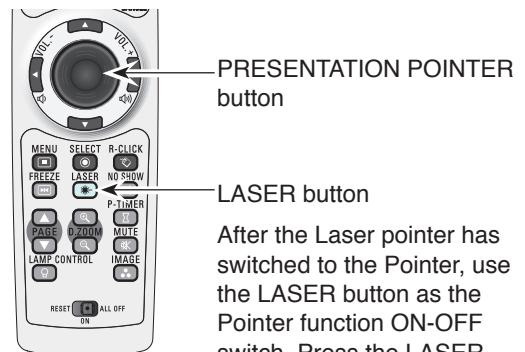
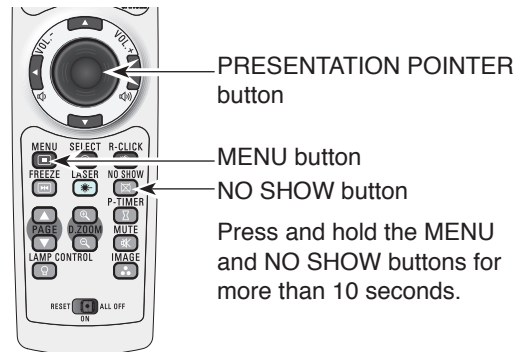

Spotlight

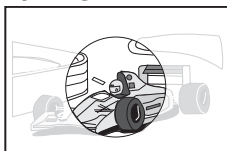

Pointer

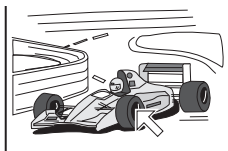

✓**Note:**

- You can choose the size of Spotlight (Large/Middle/Small) and the pattern of Pointer (Arrow/Finger/Dot) in the Setting Menu. See "Pointer" on page 53.

Wireless Mouse Operation

The remote control can be used as a wireless mouse for your computer.

- 1 Before operating the wireless mouse, connect your computer and the projector with a USB cable (not supplied). See “Connecting to a Computer” on page 19. When the Pointer function is used, the wireless mouse is not available.
- 2 When a USB cable is connected to the computer and the projector, turn on the projector first, then the computer. If you turn on the computer first, the wireless mouse function may not operate correctly.



PRESENTATION POINTER button

Move the pointer on the screen with this button.

R-CLICK button

Acts as right (click) mouse button while the projector and a computer are connected with a USB cable.



L-CLICK button

Acts as left (click) mouse button while the projector and a computer are connected with a USB cable.

Remote Control Code

The eight different remote control codes (Code 1–Code 8) are assigned to this projector. Switching the remote control codes prevents interference from other remote controls when several projectors or video equipment next to each other are operated at the same time. Change the remote control code for the projector first before changing that for the remote control. See “Remote control” in the Setting Menu on page 53.

- 1 Press and hold the MENU and IMAGE buttons for more than five seconds to switch between the codes. The code switches sequentially for one pressing the IMAGE button. See the list below.
- 2 To initialize the remote control code, slide the RESET/ON/ALL-OFF switch to “RESET,” and then to “ON.” The initial code is set to Code 1.



While pressing the MENU button, press the IMAGE button number of times corresponding to the remote control code.

MENU button

IMAGE button

RESET/ON/ALL-OFF switch

Remote Control Code	Number of Times Pressing IMAGE Button
Code 1	1
Code 2	2
Code 3	3
Code 4	4
Code 5	5
Code 6	6
Code 7	7
Code 8	8

Remote Control Battery Installation

- 1** Open the battery compartment lid.

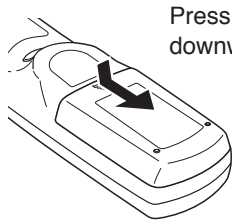

Press the lid downward and slide it.

- 2** Install new batteries into the compartment.

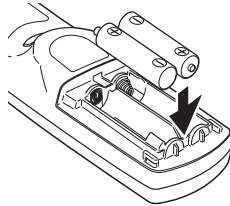

Two AAA size batteries
For correct polarity (+ and -), be sure battery terminals are in contact with pins in compartment.

- 3** Replace the compartment lid.

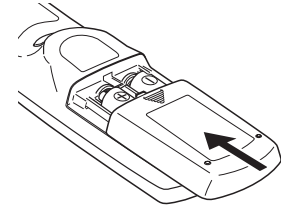

To insure safe operation, please observe the following precautions :

- Use two (2) AAA or LR03 type alkaline batteries.
- Always replace batteries in sets.
- Do not use a new battery with a used battery.
- Avoid contact with water or liquid.
- Do not expose the remote control to moisture or heat.
- Do not drop the remote control.
- If the battery has leaked on the remote control, carefully wipe the case clean and install new batteries.
- Risk of an explosion if battery is replaced by an incorrect type.
- Dispose of used batteries according to the instructions.

Remote Control Operating Range

Point the remote control toward the projector (Infrared Remote Receiver) when pressing the buttons. Maximum operating range for the remote control is about 16.4'(5 m) and 60 degrees in front of the projector.

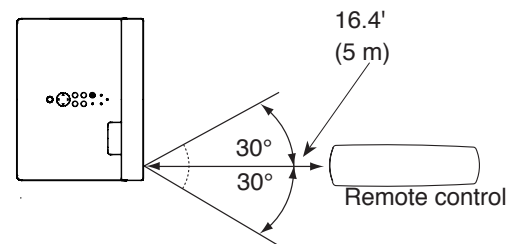

Adjustable Feet

Projection angle can be adjusted up to 8.9 degrees with the adjustable feet.

Lift the front of the projector and pull the feet lock latches on both side of the projector upward.

Release the feet lock latches to lock the adjustable feet and rotate the adjustable feet to a proper height, and tilt.

Keystone distortion can be adjusted automatically with the Auto setup function or manually by using the remote control or the menu operation (see pages 26, 47-48).

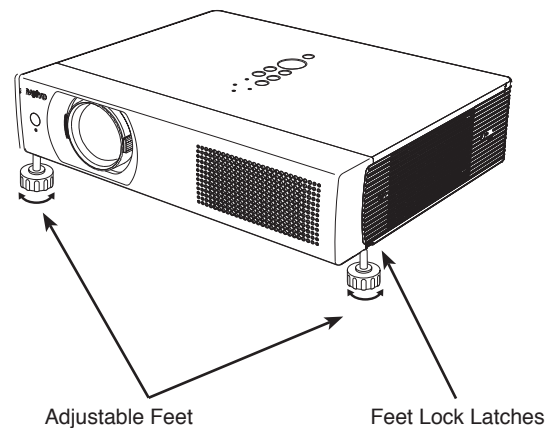

Adjustable Feet

Feet Lock Latches

Installation

Positioning the Projector

For projector positioning, see the figures below. The projector should be set perpendicularly to the plane of the screen.

✓ **Notes:**

- The brightness in the room has a great influence on picture quality. It is recommended to limit ambient lighting in order to obtain the best image.
- All measurements are approximate and may vary from the actual sizes.

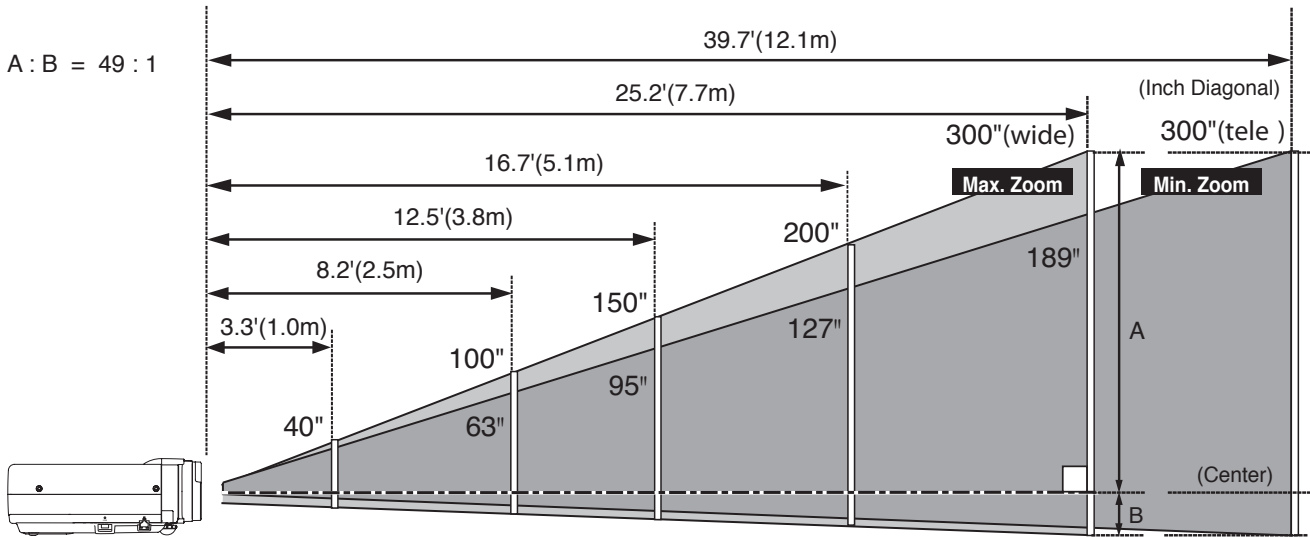

Screen Size (W x H) mm	40"	100"	150"	200"	300"
16 : 10 aspect ratio	862 x 538	2154 x 1346	3231 x 2019	4308 x 2692	6462 x 4039
Zoom (min)	5.2'(1.6m)	13.1'(4.0m)	19.7'(6.0m)	26.86(8.1m)	39.7'(12.1m)
Zoom (max)	3.3'(1.0m)	8.2'(2.5m)	12.5'(3.8m)	16.7'(5.1m)	25.2'(7.7m)

Connecting the AC Power Cord

This projector uses nominal input voltages of 100-120 V or 200–240 V AC and it automatically selects the correct input voltage. It is designed to work with single-phase power systems having a grounded neutral conductor. To reduce the risk of electrical shock, do not plug into any other type of power system.

If you are not sure of the type of power being supplied, consult your authorized dealer or service station.

Connect the projector with all peripheral equipment before turning the projector on.

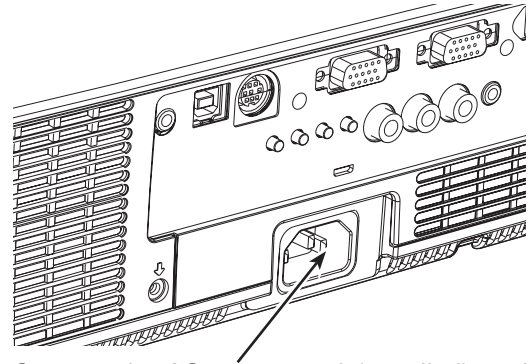

Connect the AC power cord (supplied) to the projector.

The AC outlet must be near this equipment and must be easily accessible.



CAUTION

For safety, unplug the AC power cord when the projector is not in use. When this projector is connected to an outlet with the AC power cord, it is in Stand-by mode and consumes a little electric power.

NOTE ON THE POWER CORD

AC power cord must meet requirement of the country where you use the projector. Confirm the AC plug type with the chart below and proper AC power cord must be used. If supplied AC power cord does not match your AC outlet, contact your sales dealer.

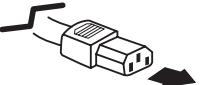
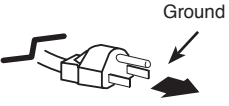
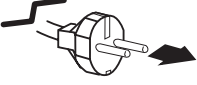
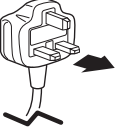
Projector side	AC outlet side		
 <p data-bbox="167 1522 365 1606">To power cord connector on your projector.</p>	<p data-bbox="430 1344 738 1375">For the U.S.A. and Canada</p>  <p data-bbox="462 1543 657 1606">To the AC outlet. (120 V AC)</p>	<p data-bbox="779 1344 1047 1375">For Continental Europe</p>  <p data-bbox="820 1543 998 1606">To the AC outlet. (200 - 240 V AC)</p>	<p data-bbox="1209 1344 1347 1375">For the U.K.</p>  <p data-bbox="1226 1543 1404 1606">To the AC outlet. (200 - 240 V AC)</p>

Connecting to a Computer

Cables used for connection

- VGA Cable (Mini D-sub 15 pin) *
- DVI-I/VGA Cable
- DVI Cable
- USB Cable
- Audio Cables

(*One cable is supplied; other cables are not supplied with the projector.)

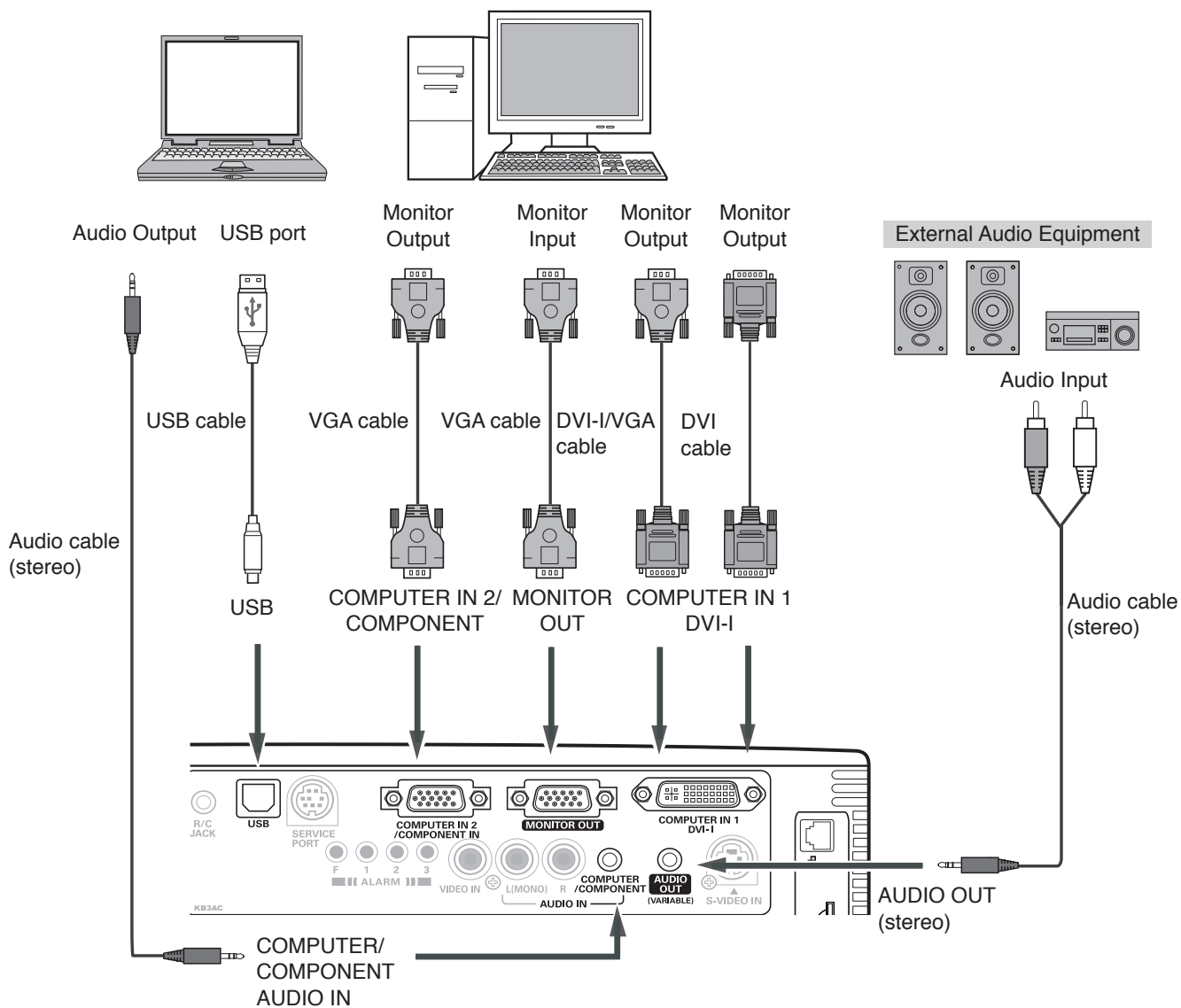

Notes:

- Input sound to the COMPUTER/COMPONENT AUDIO IN terminal when using the COMPUTER IN 1/DVI-I and the COMPUTER IN 2/ COMPONENT IN terminal as input.
- When the AUDIO OUT is plugged-in, the projector's built-in speaker is not available.
- USB cable connection is needed when operating the computer with the remote control or using the PAGE ▲▼ buttons on the remote control.

 Unplug the power cords of both the projector and external equipment from the AC outlet before connecting cables.

Connecting to Video Equipment

Cables used for connection

- Video and Audio Cable (RCA x 3)
 - S-VIDEO Cable
 - Audio Cable
- (Cables are not supplied with the projector.)

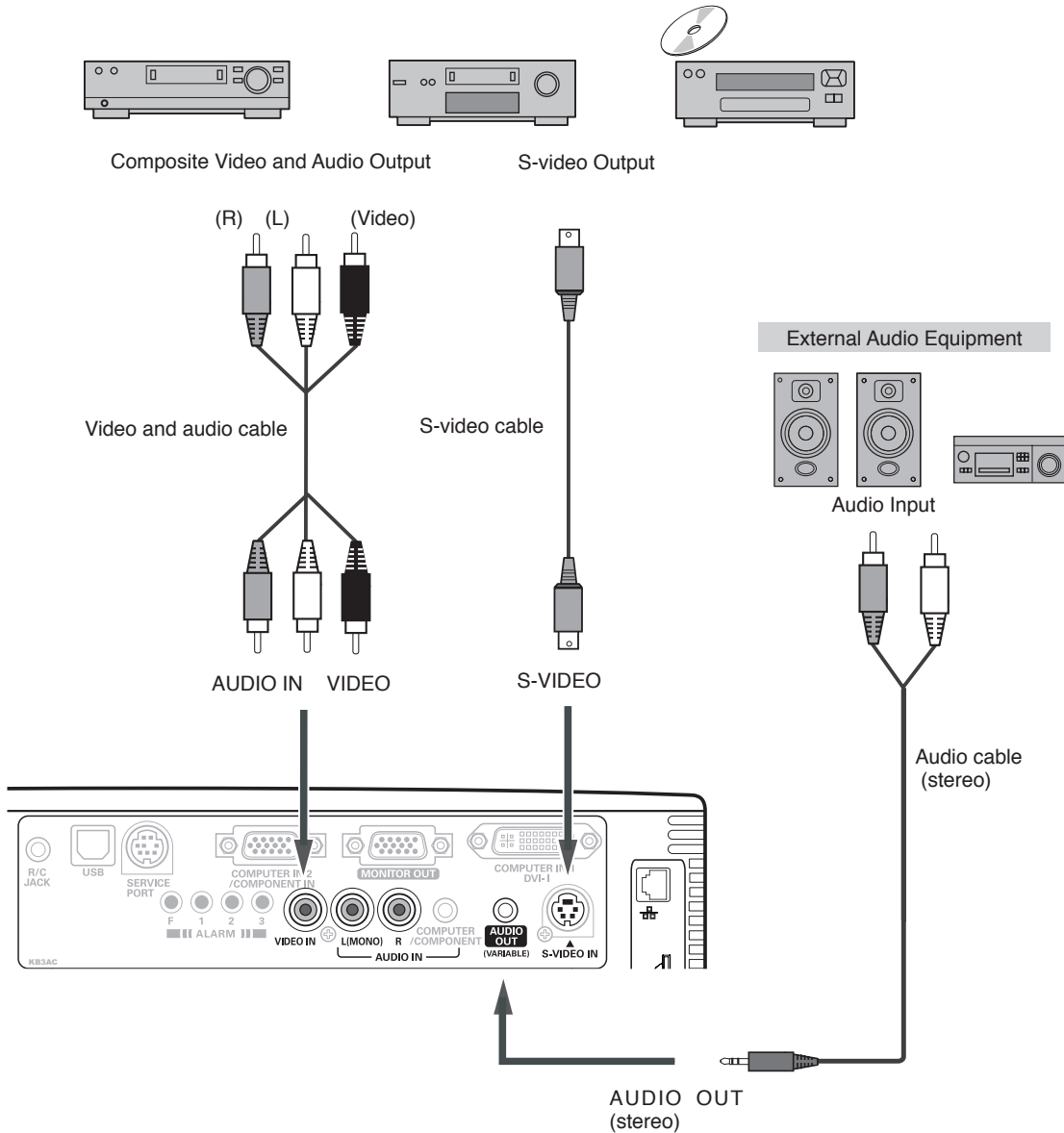

Notes:

- When the AUDIO OUT is plugged-in, the projector's built-in speaker is not available.
- The S-VIDEO jack connection overrides the VIDEO jack connection when selecting AUTO in the Input Menu (p.40).



Unplug the power cords of both the projector and external equipment from the AC outlet before connecting cables.

Connecting to Component Video Equipment

Cables used for connection

- Audio Cables
- Scart-VGA Cable
- Component Cable
- Component-VGA Cable

(Cables are not supplied with this projector.)

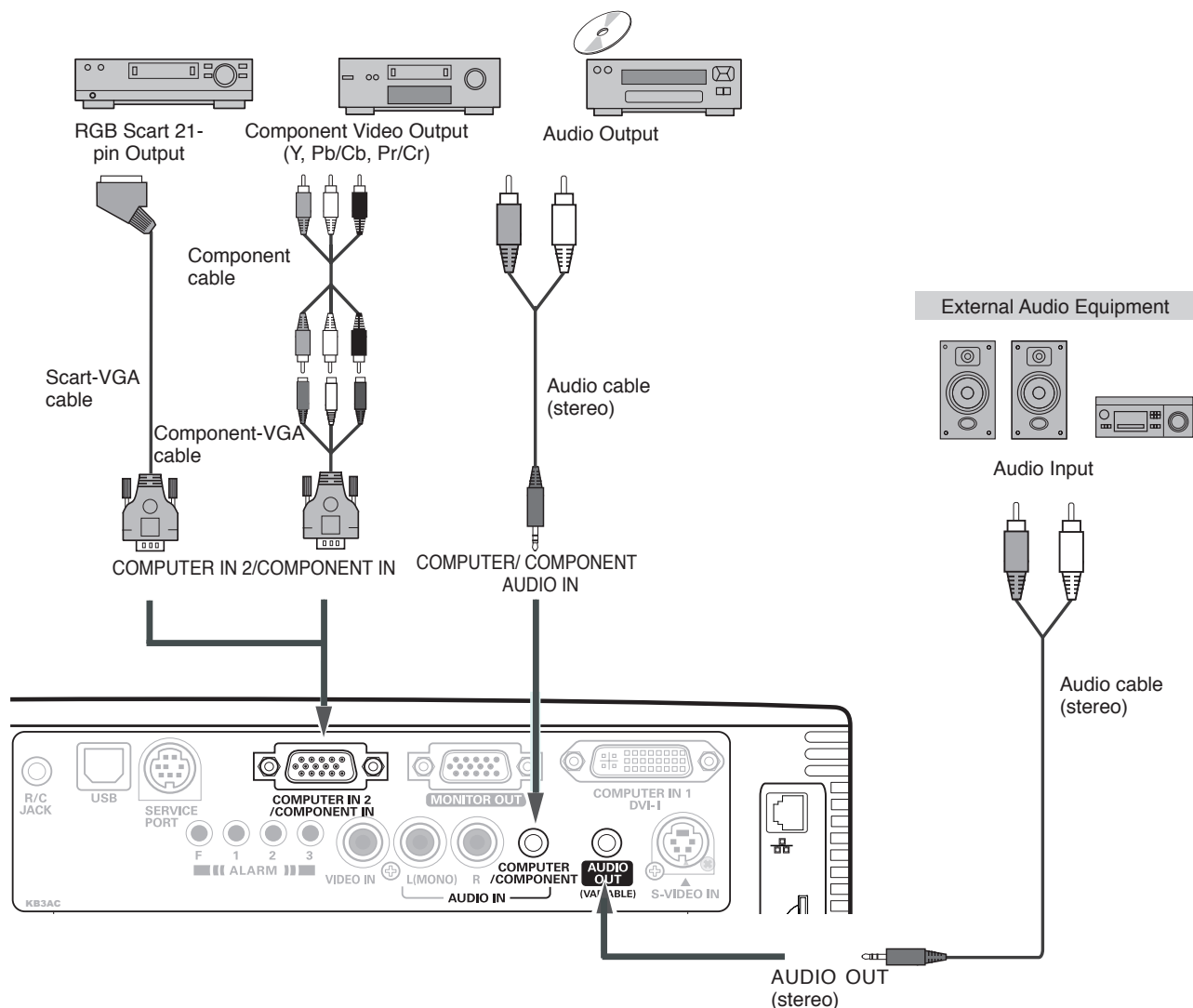

Notes:

- When the AUDIO OUT is plugged-in, the projector's built-in speaker is not available.
- See page 77 for ordering optional cables.
- RGB Scart signal cannot be output from the MONITOR OUT terminal.



Unplug the power cords of both the projector and external equipment from the AC outlet before connecting cables.

Basic Operation

Turning On the Projector

- 1 Complete peripheral connections (with a computer, VCR, etc.) before turning on the projector.
- 2 Connect the projector's AC power cord into an AC outlet. The POWER indicator lights red. Open the lens cover (see pages 10,64).
- 3 Press the POWER ON/SYAND-BY button on the top control or on the remote control. The POWER indicator lights green and the cooling fans start to operate. The preparation display appears on the screen and the count down starts.
- 4 After the countdown, the input source that was selected the last time and the lamp control status icon (see page 53) appear on the screen.

If the projector is locked with a PIN code, PIN code input dialog box will appear. Enter the PIN code as instructed below.

Enter a PIN code

Use the Point ▲▼ buttons to enter a number. Press the Point ► button to fix the number and move the red frame pointer to the next box. The number changes to “*.” If you fixed an incorrect number, use the Point ◀ button to move the pointer to the number you want to correct, and then enter the correct number.

Repeat this step to complete entering a four-digit number.

After entering the four-digit number, move the pointer to “Set.” Press the SELECT button so that you can start to operate the projector.

If you entered an incorrect PIN code, “PIN code” and the number (****) will turn red for a moment. Enter the correct PIN code all over again.

What is PIN code?

PIN (Personal Identification Number) code is a security code that allows the person who knows it to operate the projector. Setting a PIN code prevents unauthorized use of the projector.

A PIN code consists of a four-digit number. Refer to the PIN code lock function in the Setting Menu on pages 54–55 for locking operation of the projector with your PIN code.



CAUTION ON HANDLING PIN CODE

If you forget your PIN code, the projector can no longer be started. Take a special care in setting a new PIN code; write down the number in a column on page 80 of this manual and keep it at hand. Should the PIN code be missing or forgotten, consult your dealer or service center.



The preparation display will disappear after 30 seconds.

Selected Input Source and Lamp Control



(See page 51 for Lamp control status.)

✓Note:

- The Filter warning and Lamp replacement icons may appear on the screen depending on the usage state of the projector.

PIN Code Input Dialog Box

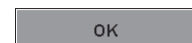
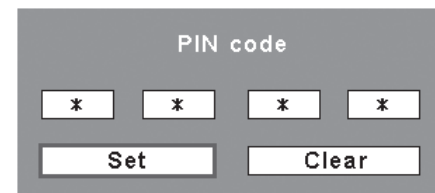

After the OK icon disappears, you can operate the projector.

✓Notes:

- When the Logo select function is set to “Off,” the logo will not be shown on the screen (p.50).
- When the “Countdown off” or “Off” is selected in the Display function, the countdown will not be shown on the screen (p.48).
- During the countdown period, all operations are invalid.
- If the correct PIN code number is not entered within three minutes after the PIN code dialog box appeared, the projector will be turned off automatically.
- The “1234” is set as the initial PIN code at the factory.
- When the Input Search function is set to “On2”, the input signal will be searched automatically (p.51)

Turning Off the Projector

- 1 Press the POWER ON/STAND-BY button on the top control or on the remote control, and “Power off?” appears on the screen.
- 2 Press the POWER ON/STAND-BY button again to turn off the projector. The POWER indicator starts to blink red, and the cooling fans keep running. (You can select the level of fans’ quietness and speed. See “Fan” on page 56.) At this time, you can unplug the AC power cord even if the fans are still running.
- 3 When the projector has cooled down enough, the POWER indicator stops blinking and you can turn on the projector.

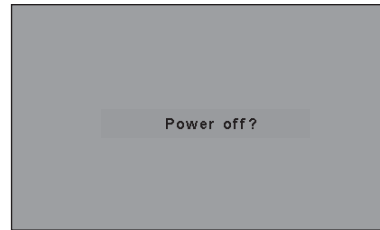

“Power off?” disappears after 4 seconds.



TO MAINTAIN THE LIFE OF THE LAMP, ONCE YOU TURN THE PROJECTOR ON, WAIT AT LEAST FIVE MINUTES BEFORE TURNING IT OFF.



DO NOT OPERATE THE PROJECTOR CONTINUOUSLY WITHOUT REST. CONTINUOUS USE MAY RESULT IN SHORTENING THE LAMP LIFE. TURN OFF THE PROJECTOR AND LET STAND FOR ABOUT AN HOUR IN EVERY 24 HOURS.

✓Notes:

- When the On start function is set to “On,” the projector will be turned on automatically by connecting the AC power cord to an AC outlet (p.53).
- The running speed of cooling fans is changed according to the temperature inside the projector.
- Do not put the projector in a case before the projector is cooled enough.
- If the WARNING indicator blinks or lights red, see “Warning Indicators” on page 62.
- While the POWER indicator is blinking, the lamp is being cooled down and the projector cannot be turned on. Wait until the POWER indicator stops blinking to turn on the projector again.
- The fan rotation will terminate directly if the AC power cord is unplugged immediately after the projector is turned off.
- The projector can be turned on after the POWER indicator turns red. The waiting time to restart will be shortened when the normal power-off processing for fan cooling is completed, compared with the time the AC power cord is immediately unplugged after the power-off.

How to Operate the On-Screen Menu

The projector can be adjusted or set via the On-Screen Menu. For each adjustment and setting procedure, refer to the respective sections in this manual.

- 1** Press the MENU button on the top control or the remote control to display the On-Screen Menu.
- 2** Use the Point ◀▶ buttons to select a Menu icon. Use the Point ▲▼ buttons to select an item in the selected menu.
- 3** Press the SELECT button to show the item data. Use the Point ◀▶ buttons to adjust the values.

To close the On-Screen Menu, press the MENU button again.

✓Note:

- The selected item is not active until the SELECT button is pressed.

Top Control

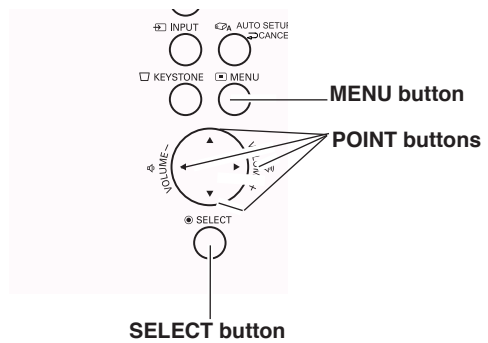

Remote Control

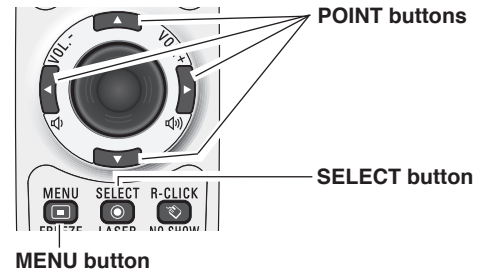

On-Screen Menu

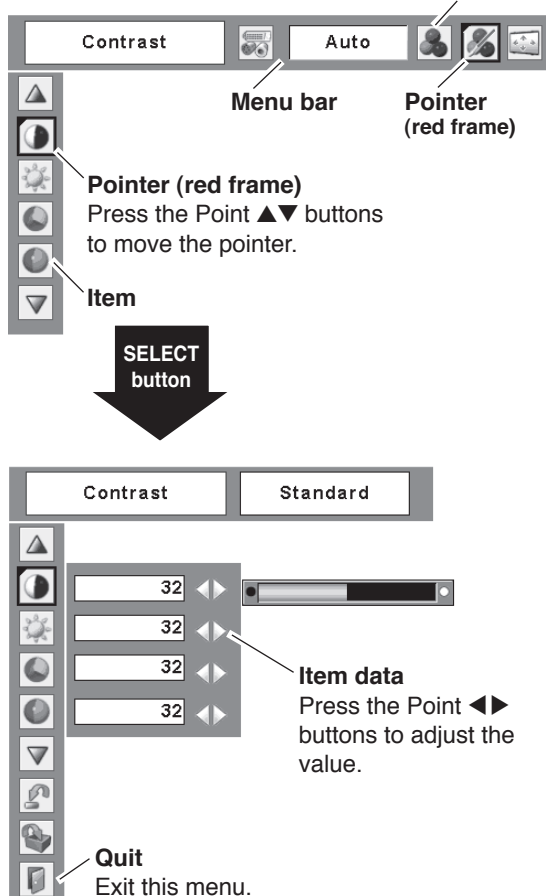

Menu Bar

For detailed functions of each menu, see “Menu Tree” on pages 71-72.

For computer source

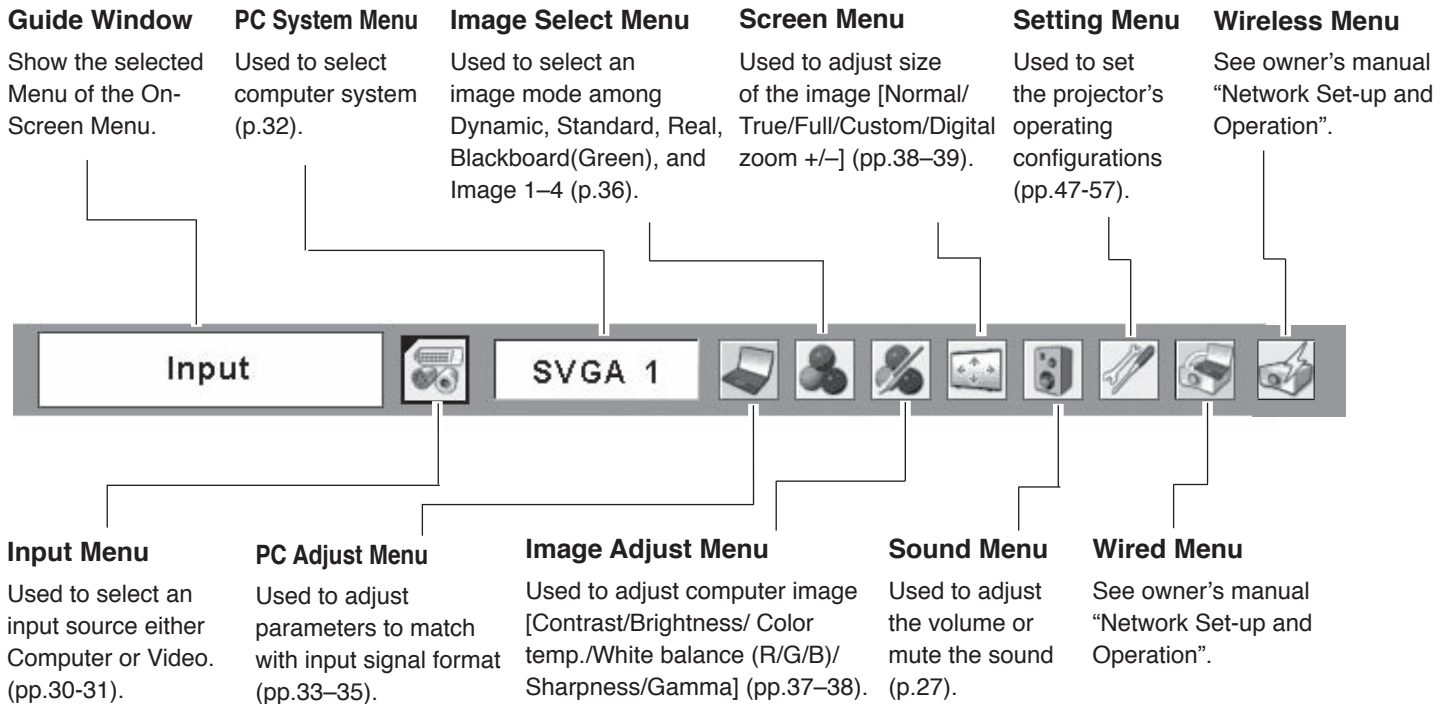

For video source

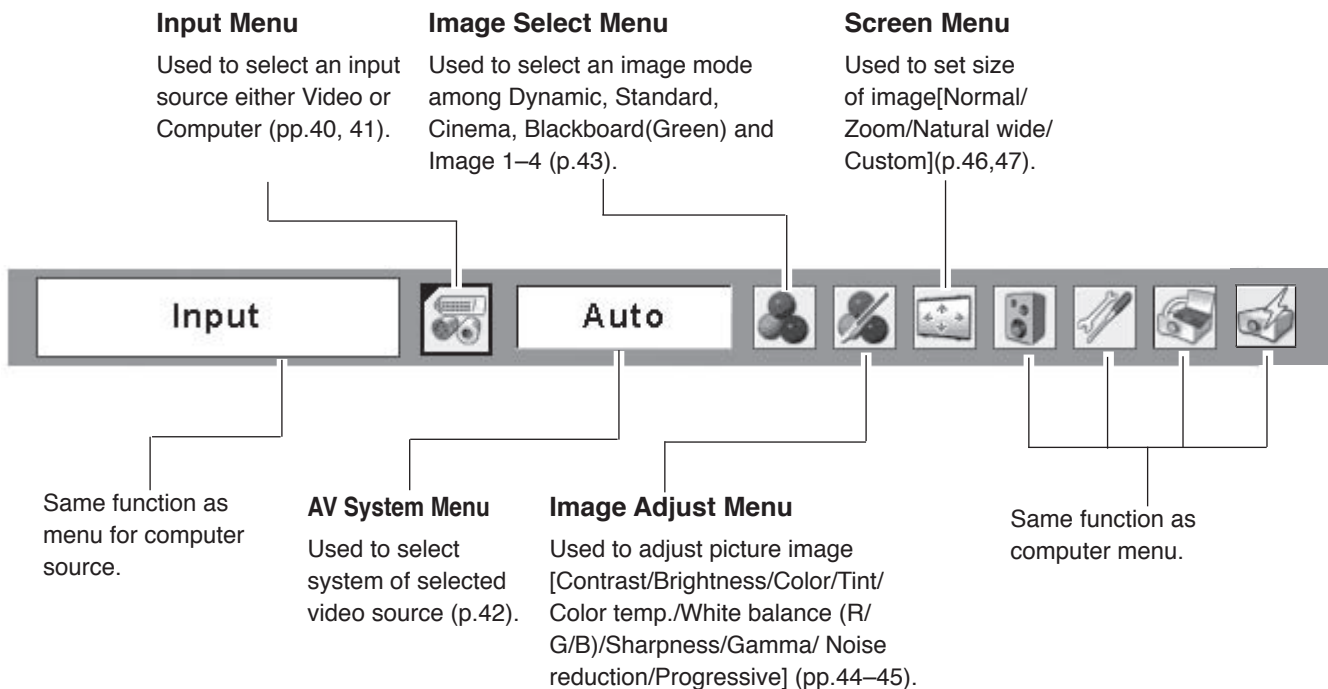

Zoom and Focus Adjustment

Rotate the Zoom Ring to zoom in and out.
 Rotate the Focus Lever to adjust the focus of the image.

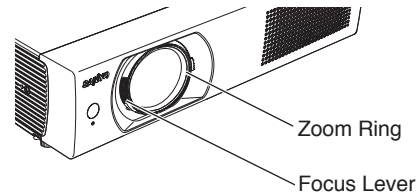

Auto Setup Function

Auto setup function is provided to automatically correct Keystone distortion according to the projector's tilt and adjust the computer display parameters (Fine sync, Total dots, and Picture position) by just pressing the AUTO SETUP/CANCEL button on the top control or the AUTO SET/CANCEL button on the remote control. The operational setup for the Auto setup can be changed in the Setting menu. Refer to page 47 for the setting of the Auto setup function.

Notes:

- Auto Keystone corrects vertical distortion only; it does not correct horizontal distortion.
- Auto Keystone cannot work when Ceiling feature is set to "On" in the Setting menu (p.51).
- Perfect correction of the image distortion cannot be ensured with the Auto setup function. If the distortion cannot be corrected properly by pressing the AUTO SETUP/CANCEL or AUTO SET/CANCEL button, adjust manually by pressing the KEYSTONE button on the remote control or selecting Keystone in the Setting menu (p.48).
- Fine sync, Total dots, Horizontal and Vertical position of some computers cannot be fully adjusted with the Auto PC Adjustment function. When the image is not provided properly with this operation, manual adjustments are required (pp.34–35).

Top Control

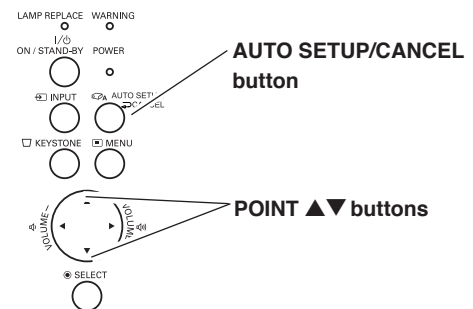

Remote Control

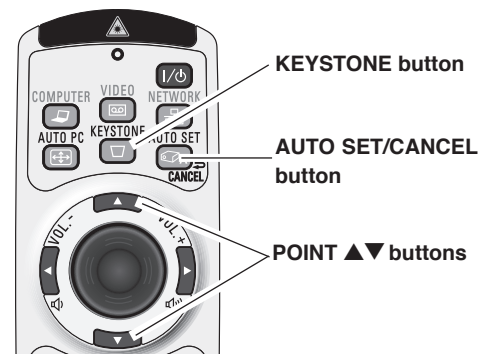

Keystone Correction

If a projected picture still has keystone distortion after pressing the AUTO SETUP/CANCEL button on the top control or the AUTO SET/CANCEL button on the remote control, correct the image manually as follows:

Press the KEYSTONE button on the remote control. The Keystone dialog box appears. Use the Point ▲▼ buttons to correct keystone distortion. The keystone adjustment can be stored (see page 48).

Reduce the upper width with the Point ▲ button.

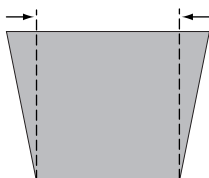

Reduce the lower width with the Point ▼ button.

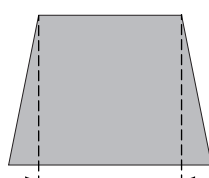

- The white arrows indicate that there is no correction.
- A red arrow indicates the direction of correction.
- An arrow disappears at the maximum correction.
- If you press the KEYSTONE button on the remote control once more while the keystone dialog box is being displayed, the keystone adjustment will be canceled.
- The adjustable range is limited depending on the input signal.

Sound Adjustment

Direct Operation

Volume

Press the VOLUME+/- buttons on the top control or on the remote control to adjust the volume. The volume dialog box appears on the screen for a few seconds.

Mute

Press the MUTE button on the remote control to temporarily turn off the sound. To turn the sound back on, press the MUTE button again or press the VOLUME +/- buttons. The Mute function is also effective for the AUDIO OUT jack.

Menu Operation

- 1 Press the MENU button to display the On-Screen Menu. Use the Point ◀▶ buttons to move the red frame pointer to the Sound Menu icon.
- 2 Use the Point ▲▼ buttons to move the red frame pointer to the desired item, and then press the SELECT button.

Volume

Press the Point ▶ button to turn up the volume; press the Point ◀ button to turn down the volume.

Mute

Press the Point ◀▶ buttons to switch the mute function On/Off. When the sound is turned off, "On" is displayed. Press the Point ◀▶ buttons again to turn the sound back on.

Top Control

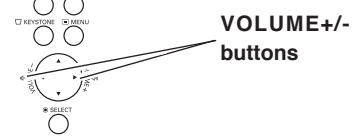

Remote Control

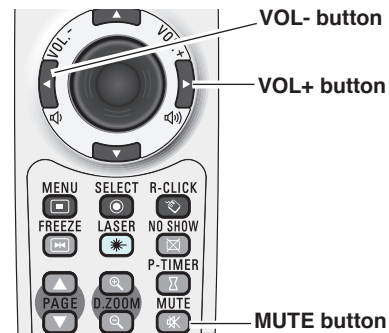

Volume Dialog Box

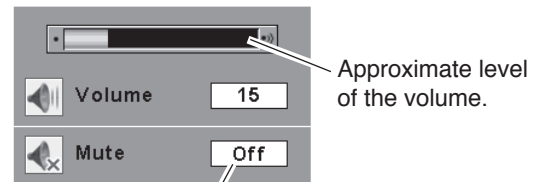

Press the MUTE button to set the Mute function On or Off. The dialog box disappears after 4 seconds.

Sound Menu

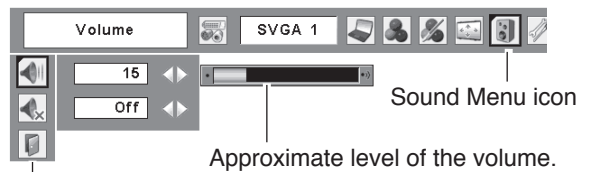

Remote Control Operation

Using the remote control for some frequently used operations is advisable. Just pressing one of the buttons enables you to make the desired operation quickly without calling up the On-Screen Menu.

COMPUTER/VIDEO/NETWORK button

Press the COMPUTER, VIDEO, or NETWORK button on the remote control to select the input source. See pages 30-31, 40-41 for details.

Refer to the owner's manual "Network Set-up and Operation" for details about the network input.

FREEZE button

Press the FREEZE button on the remote control to freeze the picture on the screen. To cancel the Freeze function, press the FREEZE button again or press any other button.

AUTO PC button

Press the AUTO PC button on the remote control to operate the Auto PC Adj. function. The computer screen adjustment can be done easily by pressing this button. See page 33 for details.

D.ZOOM buttons

Press the D.ZOOM buttons on the remote control to enter to the Digital zoom +/- mode. See page 39 for details.

LAMP CONTROL button

Press the LAMP CONTROL button on the remote control to select the lamp mode for changing the brightness on the screen.

- 🔦 Auto The brightness according to the input signal (between High and Eco mode).
- 🔦 High Brighter than the Normal mode.
- 🔦 Normal Normal brightness
- 🔦 Eco Lower brightness reduces the lamp power consumption and extends the lamp life.

Remote Control

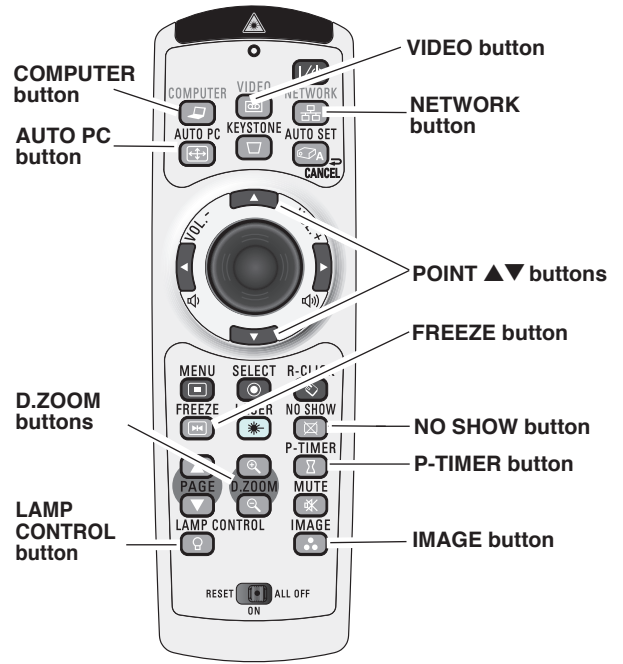

✓Note:

- See the next page for the description of other buttons.

NO SHOW button

Press the NO SHOW button on the remote control to black out the image. To restore to normal, press the NO SHOW button again or press any other button. When a projected image is captured and set as “User” in the Logo selection (see page 49), the screen changes each time you press the NO SHOW button as follows.

black out → the captured image → normal → …

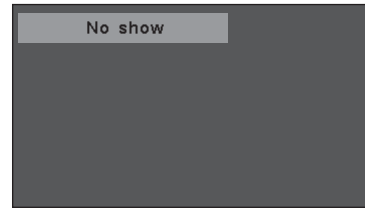

“No show” disappears after 4 seconds.

P-TIMER button

Press the P-TIMER button on the remote control. The P-Timer display “00:00” appears on the screen and the countdown starts (00:00–59:59).

To stop the countdown, press the P-TIMER button. To cancel the P-Timer function, press the P-TIMER button again.



P-Timer display

IMAGE button

Press the IMAGE button on the remote control to select a desired image mode of the screen. See pages 36, 43 for details.

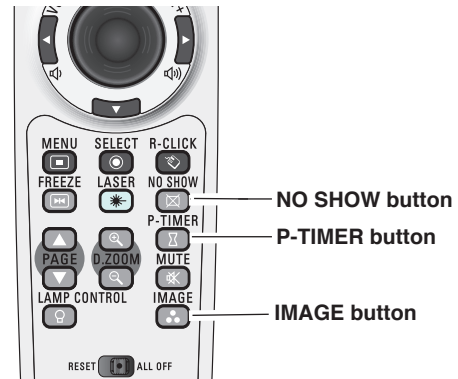

✓Note:

- See the previous page for the description of other buttons.

Computer Input

Input Source Selection (RGB: Computer 1 (Analog)/Computer 2)

Direct Operation

Choose either Computer 1 (Analog) or Computer 2 by pressing the INPUT button on the top control or press the COMPUTER button on the remote control. Before using these buttons, correct input source should be selected through Menu operation as described below.

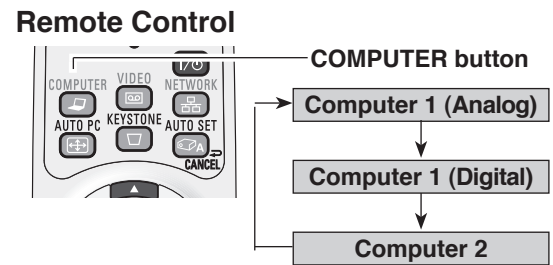
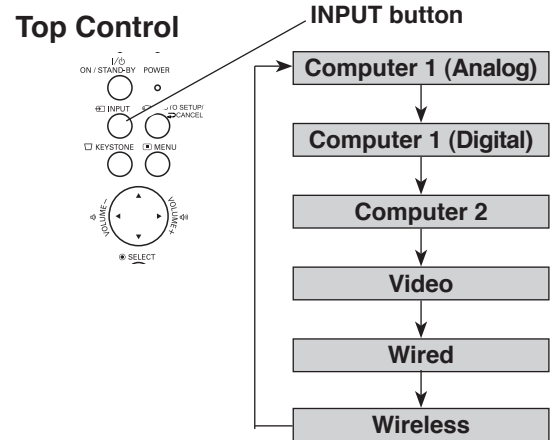

Menu Operation

- 1 Press the MENU button to display the On-Screen Menu. Use the Point ◀▶ buttons to move the red frame pointer to the Input Menu icon.
- 2 Use the Point ▲▼ buttons to move the red arrow pointer to either Computer 1 (Analog) or Computer 2, and then press the SELECT button.
- 3 When selecting Computer 1 (Analog), RGB input source will be selected directly. When selecting Computer 2, the Source Select Menu appears. Move the pointer to RGB and then press the SELECT button.

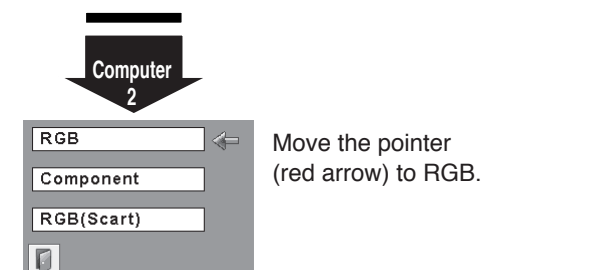
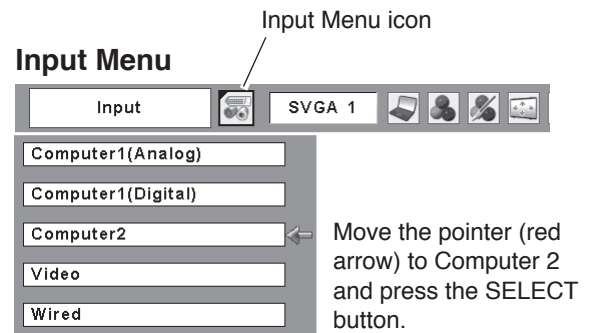
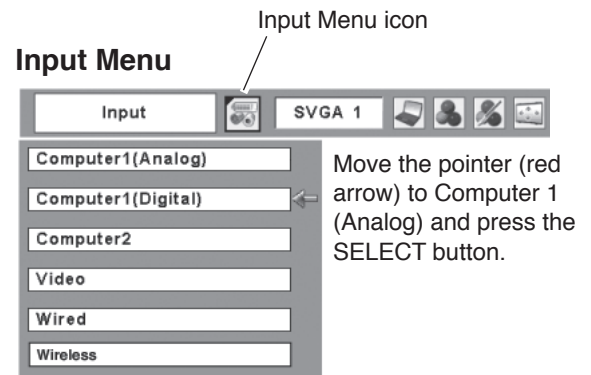

✓Notes:

- Wired and Wireless are for the Network function. See owner's manual "Network Set-up and Operation".
- When the Input Search function is set to "On1" or "On2", the input signal will be searched automatically (p.51).

Input Source Selection (RGB(PC digital), RGB(AV HDCP))

Direct Operation

Choose Computer 1 (Digital) by pressing the INPUT button on the top control or press the COMPUTER button on the remote control.

Before using these buttons, correct input source should be selected through Menu operation as described below.

Top Control

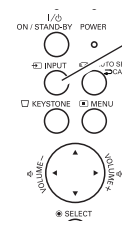

INPUT button

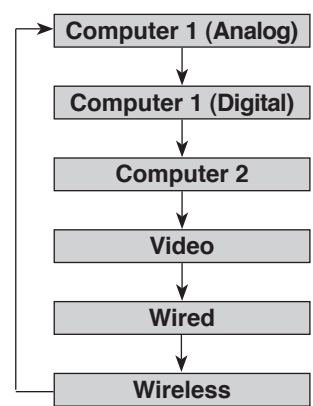

Remote Control



COMPUTER button

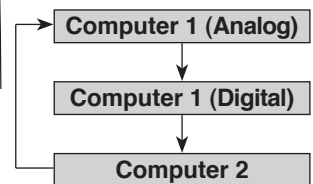

Menu Operation

- 1 Press the MENU button to display the On-Screen Menu. Use the Point ◀▶ buttons to move the red frame pointer to the Input Menu icon.
- 2 Use the Point ▲▼ buttons to move the red arrow pointer to Computer 1 (Digital), and then press the SELECT button.
- 3 After the Source Select Menu appeared for Computer 1 (Digital), move the pointer to RGB (PC digital) or RGB (AV HDCP), and then press the SELECT button.

✓Notes:

- HDCP (High-bandwidth Digital Content Protection) is a system for protecting digital entertainment content delivered by DVI (Digital Visual Interface) from being copied. The specification of HDCP is decided and controlled by Digital Content Protection, LLC. Should the specification be changed, this projector may not display the digital content protected by HDCP.
- Wired and Wireless are for the Network function. See owner's manual "Network Set-up and Operation".
- When the Input Search function is set to "On1" or "On2", the input signal will be searched automatically (p.51).

Input Menu icon

Input Menu

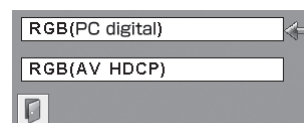
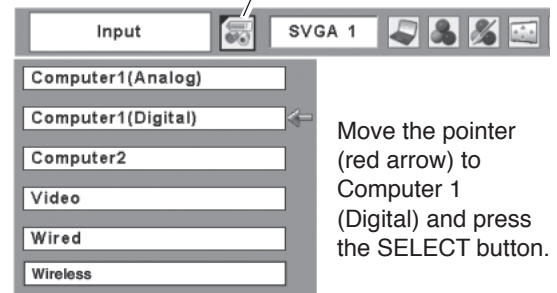

Move the pointer to the source that you want to select and press the SELECT button.

Computer System Selection

This projector automatically tunes to various types of computers based on VGA, SVGA, XGA, SXGA, WXGA, or UXGA with its Multi-scan system and Auto PC Adjustment. If a computer is selected as a signal source, this projector automatically detects the signal format and tunes to project a proper image without any additional settings. (Signal formats provided in this projector are shown on pages 74-75.)

One of the following messages may appear when:

Auto The projector cannot recognize the connected signal conforming to the provided PC Systems. The “Auto” is displayed on the System Menu box and the Auto PC Adjustment function works to display proper images. If the image is not projected properly, a manual adjustment is required (pp.34-35).

---- There is no signal input from the computer. Check the connection between your computer and the projector. (See “Troubleshooting” on page 67.)

Mode 1 The preset system is manually adjusted in the PC Adjust Menu. The adjusted data can be stored in Mode 1–5 (pp.34-35).

SVGA 1 PC Systems provided in this projector is chosen. The projector chooses a proper system provided in the projector and displays it.

*Mode 1 and SVGA 1 are examples.

PC System Menu

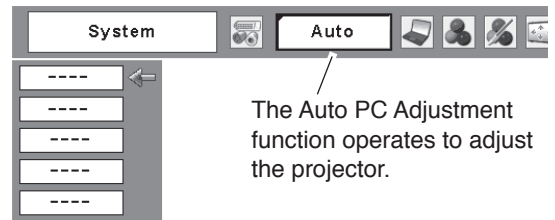

The Auto PC Adjustment function operates to adjust the projector.

PC System Menu

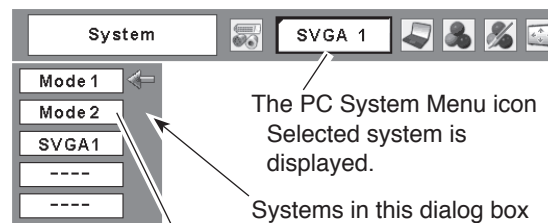

The PC System Menu icon Selected system is displayed.

Systems in this dialog box can be selected.

Customized Mode (1–5) set in the PC Adjust Menu (pp.34–35).

Selecting Computer System Manually

PC system can also be selected manually.

- 1 Press the MENU button to display the On-Screen Menu. Use the Point ◀▶ buttons to move the red frame pointer to the PC System Menu icon.
- 2 Use the Point ▲▼ buttons to move the red arrow pointer to the desired system and then press the SELECT button.

Auto PC Adjustment

Auto PC Adjustment function is provided to automatically adjust Fine sync, Total dots, Horizontal and Vertical positions to conform to your computer.

Direct Operation

The Auto PC adjustment function can be operated directly by pressing the AUTO PC button on the remote control.

Remote Control

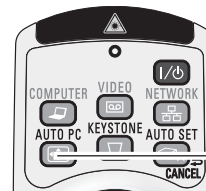

AUTO PC button

Menu Operation



Auto PC Adj.

- 1 Press the MENU button to display the On-Screen Menu. Use the Point ◀▶ buttons to move the red frame pointer to the PC Adjust Menu icon.
- 2 Use the Point ▲▼ buttons to move the red frame pointer to Auto PC Adj. and then press the SELECT button twice.

To store adjustment parameters

The adjusted parameters from the Auto PC Adjustment can be stored in the projector. Once the parameters are stored, the setting can be done just by selecting a Mode (1–5) in the PC System Menu (see page 32). See also “Store” on page 35.

✓Notes:

- Fine sync, Total dots, Horizontal and Vertical position of some computers cannot be fully adjusted with the Auto PC Adjustment function. When the image is not provided properly with this operation, manual adjustments are required (pp.34–35).
- The Auto PC Adjustment cannot be operated when 480i, 575i, 480p, 575p, 720p, 1035i, or 1080i is selected in the PC System Menu (p.32), or when the signal is coming from the DVI-terminal.

PC Adjust Menu

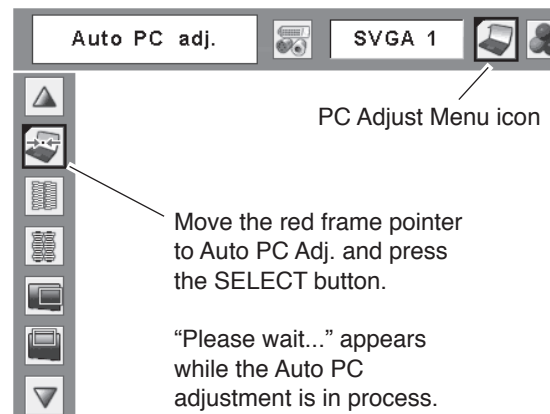

PC Adjust Menu icon

Move the red frame pointer to Auto PC Adj. and press the SELECT button.

“Please wait...” appears while the Auto PC adjustment is in process.

Manual PC Adjustment

Some computers employ special signal formats which may not be tuned by Multi-scan system of this projector. Manual PC Adjustment enables you to precisely adjust several parameters to match those signal formats. The projector has five independent memory areas to store those parameters manually adjusted. It allows you to recall the setting for a specific computer.

- 1 Press the MENU button to display the On-Screen Menu. Use the Point ◀▶ buttons to move the red frame pointer to the PC Adjust Menu icon.
- 2 Use the Point ▲▼ buttons to move the red frame pointer to the desired item and then press the SELECT button to display the adjustment dialog box. Use the Point ◀▶ buttons to adjust the setting value.

Fine sync

Use the Point ◀▶ buttons to adjust the value, eliminating a flicker from the image displayed (from 0 to 31).

Total dots

Use the Point ◀▶ buttons to adjust the number of total dots in one horizontal period to match your PC image.

Horizontal

Use the Point ◀▶ buttons to adjust the horizontal picture position.

Vertical

Use the Point ◀▶ buttons to adjust the vertical picture position.

Current mode

Press the SELECT button to show H-sync freq. and V-sync freq. of the connected computer.

Clamp

Use the Point ◀▶ buttons to adjust the clamp level. When the image has dark bars, try this adjustment.

PC Adjust Menu

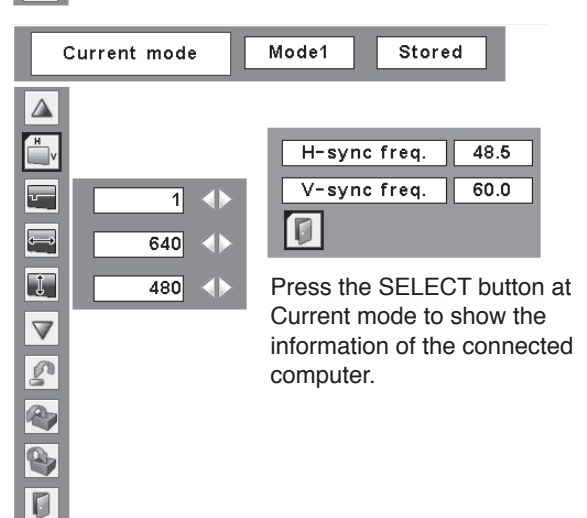
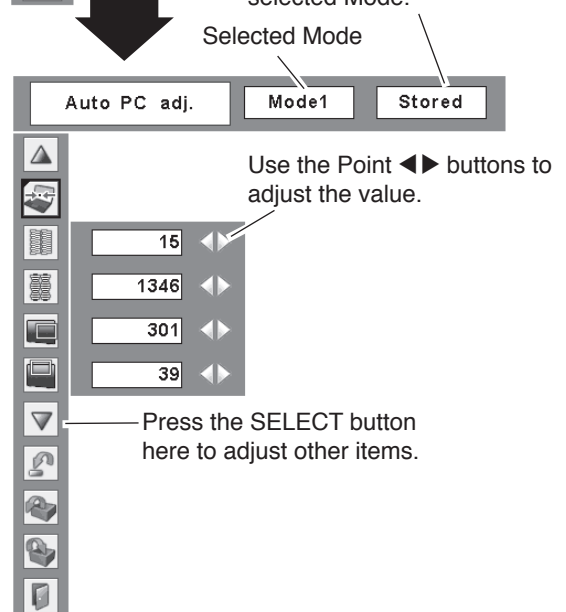
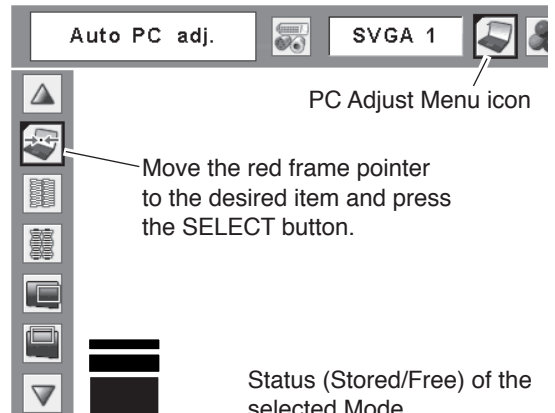

Display area H

Use the Point ◀▶ buttons to adjust the horizontal area displayed by this projector.

Display area V

Use the Point ◀▶ buttons to adjust the vertical area displayed by this projector.

Reset

To reset the adjusted data, select Reset and press the SELECT button. A confirmation box appears and then select [Yes]. All adjustments will return to their previous figures.

Mode free

To clear the stored data, select Mode free and then press the SELECT button. Move the red arrow pointer to the Mode that you want to clear and then press the SELECT button.

Store

To store the adjusted data, select Store and then press the SELECT button. Move the red arrow pointer to one of the Modes 1 to 5 in which you want to store, and then press the SELECT button.

Quit

Exit the PC Adjust Menu.

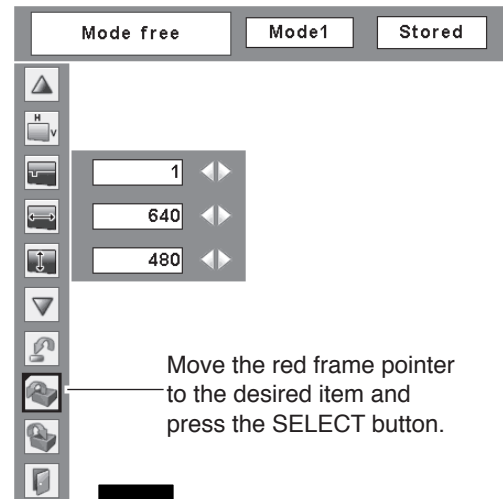

Move the red frame pointer to the desired item and press the SELECT button.



To clear adjusted data

This Mode has stored parameters.

Where to free?						
Mode1	Stored	800	142	34	1024	768
Mode2	Free	800	142	34	1024	768
Mode3	Free	800	142	34	1024	768
Mode4	Free	800	142	34	1024	768
Mode5	Free	800	142	34	1024	768

Vacant

Values of "Total dots", "Horizontal", "Vertical", "Display area H", and "Display area V".

To store adjusted data

Where to store?						
Mode1	Stored	800	142	34	1024	768
Mode2	Free	800	142	34	1024	768
Mode3	Free	800	142	34	1024	768
Mode4	Free	800	142	34	1024	768
Mode5	Free	800	142	34	1024	768

Close this dialog box.

✓Notes:

- Display area (H/V) cannot be selected when 480i, 575i, 480p, 575p, 720p, 1035i, or 1080i is selected in the PC System Menu (p.32).
- PC Adjust Menu cannot be selected when Computer 1(Digital) is selected in the Input Menu (p.31).

Image Mode Selection

Direct Operation

Select the desired image mode from among Dynamic, Standard, Real, Blackboard (Green), Image 1, Image 2, Image 3, and Image 4 by pressing the IMAGE button on the remote control.

Dynamic

For viewing pictures in a bright room.

Standard

Normal picture mode preset on the projector.

Real

Picture mode with improved halftone for graphics.

Blackboard (Green)

For the image projected on a blackboard.
This mode help enhance the image projected on a blackboard. This is mainly effective on a green colored board, not truly effective on a black colored board.

Image 1–4

For viewing with the user preset image mode in the Image Adjust Menu (see pages 37-38). This Image memory is provided in each computer, component, and video input source.

Menu Operation

- 1 Press the MENU button to display the On-Screen Menu. Use the Point ◀▶ buttons to move the red frame pointer to the Image Select Menu icon.
- 2 Use the Point ▲▼ buttons to move the red frame pointer to the desired image mode and then press the SELECT button.

Dynamic

For viewing pictures in a bright room.

Standard

Normal picture mode preset on the projector.

Real

Picture mode with improved halftone for graphics.

Blackboard(Green)

For the image projected on a blackboard. See above for further description.

Image 1~4

For viewing with the user preset image mode in the Image Adjust Menu (see pages 37-38).

Remote Control

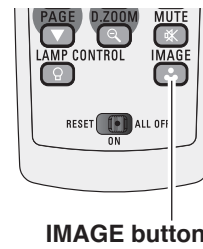

IMAGE button

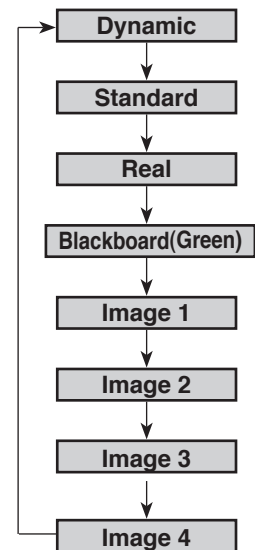
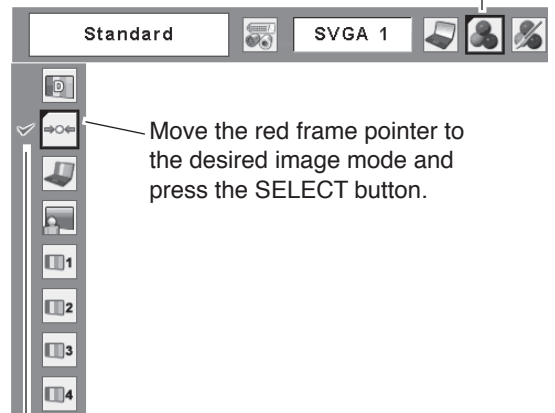

Image Select Menu



The selected image mode is check marked.

Image Adjustment

- 1 Press the MENU button to display the On-Screen Menu. Use the Point ◀▶ buttons to move the red frame pointer to the Image Adjust Menu icon.
- 2 Use the Point ▲▼ buttons to move the red frame pointer to the desired item and then press the SELECT button to display the adjustment dialog box. Use the Point ◀▶ buttons to adjust the setting value.

Contrast

Press the Point ◀ button to decrease the contrast; press the Point ▶ button to increase the contrast (from 0 to 63).

Brightness

Press the Point ◀ button to decrease the brightness; press the Point ▶ button to increase the brightness (from 0 to 63).

Color temp.

Use the Point ◀▶ buttons to select the desired Color temp. level (High, Mid, Low, or XLow).

White balance (Red)

Press the Point ◀ button to lighten red tone; press the Point ▶ button to deepen red tone (from 0 to 63).

White balance (Green)

Press the Point ◀ button to lighten green tone; press the Point ▶ button to deepen green tone (from 0 to 63).

White balance (Blue)

Press the Point ◀ button to lighten blue tone; press the Point ▶ button to deepen blue tone (from 0 to 63).

Sharpness

Press the Point ◀ button to decrease the sharpness of the image; press the Point ▶ button to increase the sharpness of the image (from 0 to 15).

Gamma

Use the Point ◀▶ buttons to adjust the gamma value to obtain a better balance of contrast (from 0 to 15).

Reset

To reset the adjusted data, select Reset and press the SELECT button. A confirmation box appears and then select [Yes]. All adjustments will return to their previous figures.

Image Adjust Menu

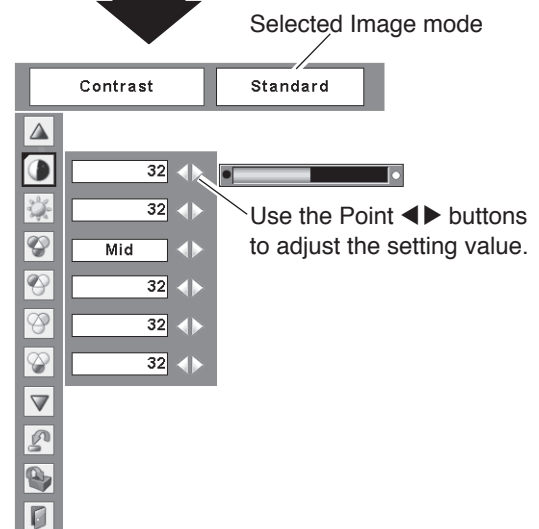
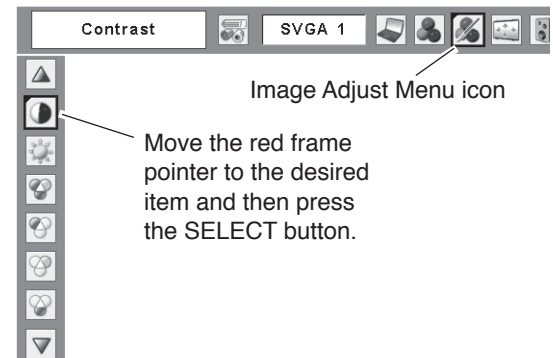

✓Note:

- When the White balance Red, Green, or Blue is adjusted, the Color temp. level will change to "Adj."

Store

To store the adjusted data, select Store and press the SELECT button. Use the Point ▲▼ buttons to select one from Image 1 to 4 and press the SELECT button. A confirmation box appears and then select [Yes]. Stored data can be called up by selecting an “Image (1–4)” in the Image Mode Selection on page 36.

Quit

Exit the Image Adjust Menu.

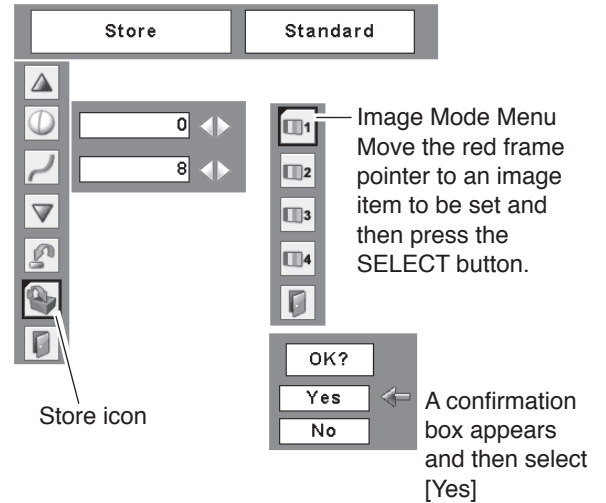

Screen Size Adjustment

This projector has the picture screen resize function, which enables you to customize the image size.

- 1 Press the MENU button to display the On-Screen Menu. Use the Point ◀▶ buttons to move the red frame pointer to the Screen Menu icon.
- 2 Use the Point ▲▼ buttons to move the red frame pointer to the desired function and then press the SELECT button.

Normal

Provide the image to fit the screen size.

True

Provide the image in its original size. When the original image size is larger than the screen size (1280 x 800), the projector enters to the panning mode automatically. Use the Point ▲▼◀▶ buttons to pan the image. When adjusted, the arrows will turn red. When reached to the correction limits, the arrows will disappear.

Full

Provide the full screen image.

Screen Menu

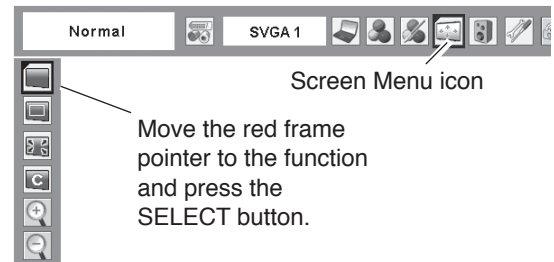

✓Notes:

- This Screen Menu cannot be operated when 720p(HDTV), 1035i (HDTV), or 1080i (HDTV) is selected in the PC System Menu (p.32).
- This projector cannot display any resolution higher than 1600 x 1200. If your computer's screen resolution is higher than it, reset the resolution to the lower before connecting to the projector.
- The image data in other than 1280 x 800 is modified to fit the screen size in initial mode.
- True, Full screen, and Digital zoom +/- cannot be selected when 480i, 575i, 480p, or 575p is selected in the PC System Menu (p.32).

Custom

Adjust the screen scale and position manually with this function.

Press the SELECT button at Custom and the “Custom” is displayed on the screen for a few seconds and then the Aspect dialog box appears.

- Scale H/V Adjust the Horizontal/Vertical screen scale.
- H&V When set to “On,” the aspect ratio is fixed. The “Scale V” appears dimmed and becomes unavailable. Adjust “Scale H,” then the screen scale is automatically modified based on the aspect ratio.
- Position H/V Adjust the Horizontal/Vertical screen position.
- Common Save the adjusted scale to all the inputs. Press the SELECT button at Common to display a confirmation box. To save the scale, press the SELECT button at “Yes.” When Custom is selected, the saved scale is used.
- Reset Reset the all adjusted values. Press the SELECT button at Reset to display a confirmation box. To reset, press the SELECT button at “Yes.”

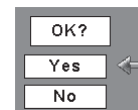
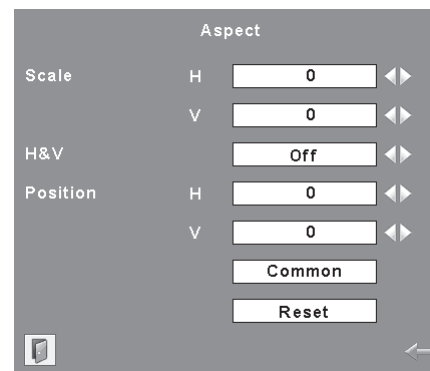

Press the SELECT button at Common or Reset, to display a confirmation box.

✓Notes:

- When no signal is detected, “Normal” is set automatically and the Aspect dialog box disappears.
- The adjustable range for Scale H/V and Position H/V is limited depending on the input signal.

For zooming in and out the images

Digital zoom +

Select Digital zoom +. The On-Screen Menu disappears and “D. zoom +” appears. Press the SELECT button to expand the image size. Use the Point ▲▼◀▶ buttons to pan the image. The Panning function can work only when the image is larger than the screen size.

A projected image can be also expanded by pressing the D.ZOOM ▲ button on the remote control.

Digital zoom -

Select Digital zoom -. The On-Screen Menu disappears and “D. zoom -” appears. Press the SELECT button to compress image size.

The projected image can be also compressed by pressing the D.ZOOM ▼ button on the remote control.

To exit the Digital zoom +/- mode, press any button except the D.ZOOM ▲▼ buttons, SELECT, and Point buttons.

To return to the previous screen size, select a screen size from the Screen Size Adjustment Menu or select an input source from the Input Source Selection Menu (see pages 30-31) again, or adjust the screen size with the D.ZOOM ▲▼ buttons.

Remote Control

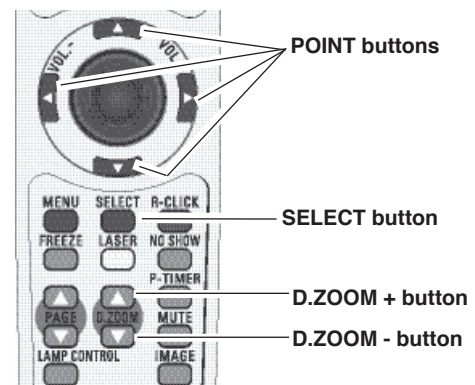

✓Notes:

- The panning function may not operate properly if the stored Mode in the PC Adjust Menu is used (p.35).
- Minimum compression ratio can be limited depending on the input signal or when the Keystone function is working.
- True, Full screen, and Digital zoom +/- cannot be selected when 480i, 575i, 480p, or 575p is selected in the PC System Menu (p.32).
- Digital zoom +/- cannot be selected when Full screen or True is selected.

Video Input

Input Source Selection (Video, S-video)

Direct Operation

Choose Video by pressing the INPUT button on the top control or the VIDEO button on the remote control. Before using these buttons, correct input source should be selected through menu operation as described below.

Menu Operation

- 1 Press the MENU button to display the On-Screen Menu. Use the Point ◀▶ buttons to move the red frame pointer to the Input Menu icon.
- 2 Use the Point ▲▼ buttons to move the red arrow pointer to Video and then press the SELECT button to display the Source Select Menu.
- 3 Move the pointer to the desired source and then press the SELECT button.

Auto When selecting Auto, the projector automatically detects incoming video signal, and adjusts itself to optimize its performance. The projector selects connection in the following order:

1. S-video
2. Video

Video When video input signal is connected to the VIDEO jack, select Video.

S-video When video input signal is connected to the S-VIDEO jack, select S-video.

✓Notes:

- Wired and Wireless are for the Network function. See the owner's manual "Network Set-up and Operation".
- When the Input Search function is set to "On1" or "On2", the input signal will be searched automatically (p.51).

Top Control

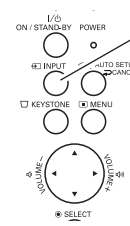

INPUT button

INPUT button

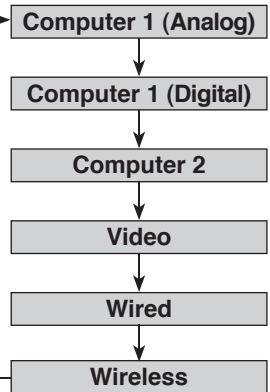

Remote Control



VIDEO button

Input Menu

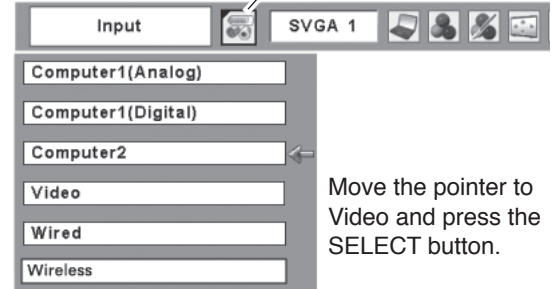

Source Select Menu (VIDEO)

Move the pointer to the source that you want to select and press the SELECT button.

Input Source Selection (Component, RGB Scart 21-pin)

Direct Operation

Choose Computer 2 by pressing the INPUT button on the top control or press the COMPUTER button on the remote control.

Before using these buttons, correct input source should be selected through Menu operation as described below.

Menu Operation

- 1 Press the MENU button to display the On-Screen Menu. Use the Point ◀▶ buttons to move the red frame pointer to the Input Menu icon.
- 2 Use the Point ▲▼ buttons to move the red arrow pointer to Computer 2 and then press the SELECT button.
- 3 After the Source Select Menu appeared for Computer 2, move the pointer to Component or RGB(Scart) and then press the SELECT button.

Component When the input source is coming from video equipment connected to the COMPUTER IN 2/COMPONENT IN terminal with a Component-VGA Cable, select Component.

RGB (Scart) When the input source is coming from video equipment connected to the COMPUTER IN 2/COMPONENT IN terminal with a Scart-VGA Cable, select RGB (Scart).

✓**Note:**

- Wired and Wireless are for the Network function. See owner's manual "Network Set-up and Operation" .
- When the Input Search function is set to "On1" or "On2", the input signal will be searched automatically (p.51).

Top Control

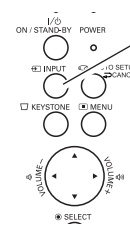

INPUT button

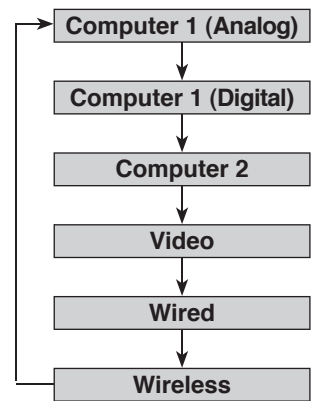

Remote Control

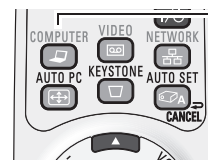

COMPUTER button

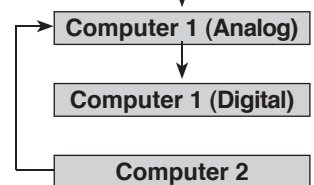

Input Menu

Input Menu icon

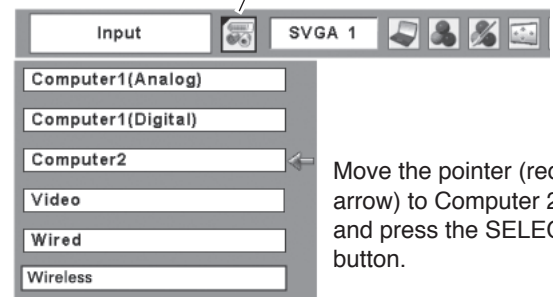

Source Select Menu

Move the pointer to Component or RGB(Scart) and press the SELECT button.

Video System Selection

- 1 Press the MENU button to display the On-Screen Menu. Use the Point ◀▶ buttons to move the red frame pointer to the AV System Menu icon.
- 2 Use the Point ▲▼ buttons to move the red arrow pointer to the desired system and then press the SELECT button.

Video or S-Video

Auto

The projector automatically detects an incoming video system, and adjusts itself to optimize its performance. When Video System is PAL-M or PAL-N, select the system manually.

PAL/SECAM/NTSC/NTSC4.43/PAL-M/PAL-N

If the projector cannot reproduce proper video image, select a specific broadcast signal format from among PAL, SECAM, NTSC, NTSC 4.43, PAL-M, and PAL-N.

AV System Menu (Video or S-Video)

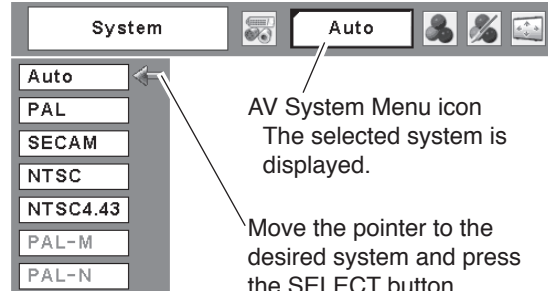

Component

Auto

The projector automatically detects an incoming video signal, and adjusts itself to optimize its performance.

COMPONENT VIDEO SIGNAL FORMAT

If the projector cannot reproduce proper video image, select a specific component video signal format from among 480i, 575i, 480p, 575p, 720p, 1035i, and 1080i.

AV System Menu (Component)

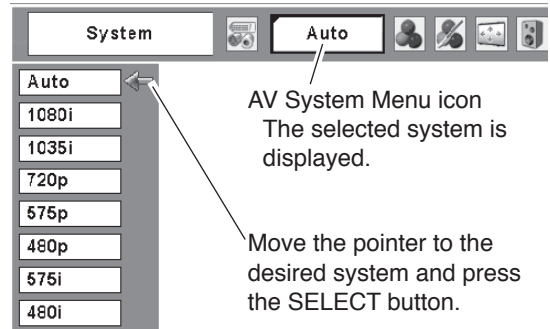

✓Note:

- The AV System Menu cannot be selected when selecting RGB (Scart).

Image Mode Selection

Direct Operation

Select the desired image mode from among Dynamic, Standard, Cinema, Blackboard (Green), Image 1, Image 2, Image 3, and Image 4 by pressing the IMAGE button on the remote control.

Dynamic

For viewing pictures in a bright room.

Standard

Normal picture mode preset on the projector.

Cinema

Picture mode adjusted with fine tone.

Blackboard (Green)

For the image projected on a blackboard.
This mode help enhance the image projected on a blackboard. This is mainly effective on a green colored board, not truly effective on a black colored board.

Image 1–4

For viewing with the user preset image mode in the Image Adjust Menu (see pages 44–45). This Image memory is provided in each computer, component, and video input source.

Menu Operation

- 1 Press the MENU button to display the On-Screen Menu. Use the Point ◀▶ buttons to move the red frame pointer to the Image Select Menu icon.
- 2 Use the Point ▲▼ buttons to move the red frame pointer to the desired image mode and then press the SELECT button.

Dynamic

For viewing pictures in a bright room.

Standard

Normal picture mode preset on the projector.

Cinema

Picture mode adjusted with fine tone.

Blackboard (Green)

For the image projected on a blackboard. See above for further description.

Image1–4

For viewing with the user preset image mode in the Image Adjust Menu (see pages 44–45).

Remote Control

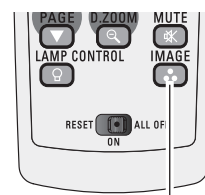

IMAGE button

IMAGE button

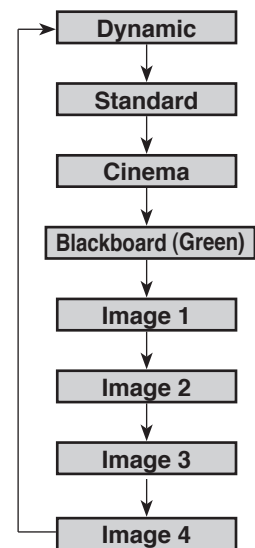
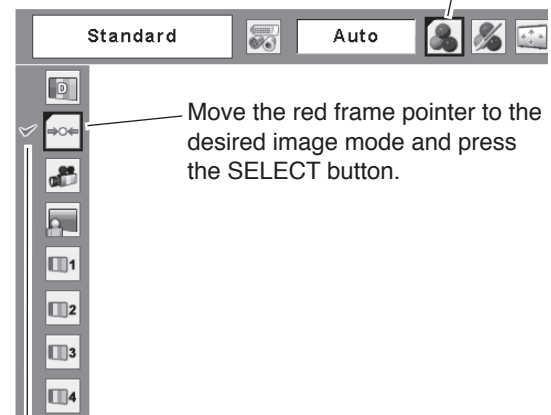

Image Select Menu

Image Select Menu icon



Move the red frame pointer to the desired image mode and press the SELECT button.

The selected image mode is check marked.

Image Adjustment

- 1 Press the MENU button to display the On-Screen Menu. Use the Point ◀▶ buttons to move the red frame pointer to the Image Adjust Menu icon.
- 2 Use the Point ▲▼ buttons to move the red frame pointer to the desired item and then press the SELECT button to display the adjustment dialog box. Use the Point ◀▶ buttons to adjust the setting value.

Contrast

Press the Point ◀ button to decrease the contrast; press the Point ▶ button to increase the contrast (from 0 to 63).

Brightness

Press the Point ◀ button to decrease the brightness; press the Point ▶ button to increase the brightness (from 0 to 63).

Color

Press the Point ◀ button decrease the intensity of the color; press the Point ▶ button increase the intensity of the color (from 0 to 63).

Tint

Press the Point ◀▶ buttons to adjust the tint value to get a proper color balance (from 0 to 63).

Color temp.

Use the Point ◀▶ buttons to select the desired Color temp. level (High, Mid, Low, or XLow).

White balance (Red)

Press the Point ◀ button to lighten red tone; press the Point ▶ button to deepen red tone (from 0 to 63).

White balance (Green)

Press the Point ◀ button to lighten green tone; press the Point ▶ button to deepen green tone (from 0 to 63).

White balance (Blue)

Press the Point ◀ button to lighten blue tone; press the Point ▶ button to deepen blue tone (from 0 to 63).

✓Notes:

- When the White balance Red, Green, or Blue is adjusted, the Color temp. level will change to “Adj.”.
- Tint cannot be selected when the video system is PAL, SECAM, PAL-M, or PAL-N (p.42).

Image Adjust Menu

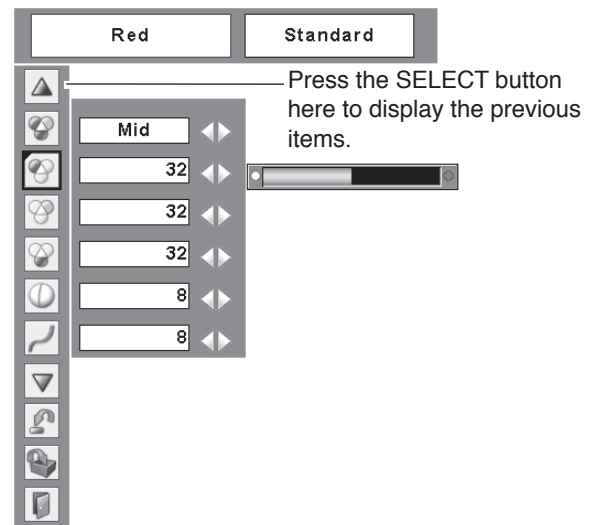
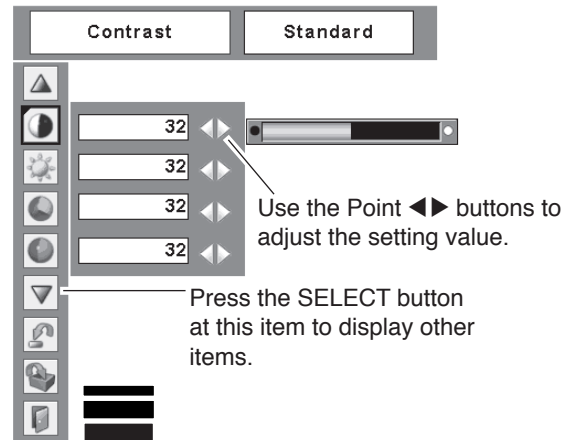
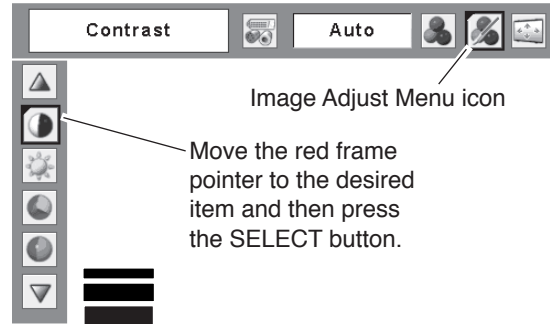

Sharpness

Press the Point ◀ button to decrease the sharpness of the image; press the Point ▶ button to increase the sharpness of the image (from 0 to 15).

Gamma

Use the Point ◀▶ buttons to adjust the gamma value to obtain a better balance of contrast (from 0 to 15).

Noise reduction

Noise interference on the screen can be reduced. Select one of the following options to get smoother images.

- Off Disabled.
- L1 Lower reduction
- L2 Higher reduction

Progressive

An interlaced video signal can be displayed in progressive mode. Select one of the following options.

- Off Disabled.
- L1 For an active picture.
- L2 For a still picture.
- Film For watching a film. With this function, the projector reproduces pictures faithful to the original film quality.

Reset

To reset the adjusted data, select Reset and press the SELECT button. A confirmation box appears and then select [Yes]. All adjustments will return to their previous figures.

Store

To store the adjusted data, select Store and press the SELECT button. Use the Point ▲▼ buttons to select one from Image 1 to 4 and press the SELECT button. A confirmation box appears and then select [Yes]. Stored data can be called up by selecting an “Image (1–4)” in the Image Select Menu on page 43.

Quit

Exit the Image Adjust Menu.

✓Notes:

- Noise reduction and Progressive cannot be selected when 480p, 575p, 720p, 1035i, or 1080i is selected (p.42).
- Reset and Store icons will be displayed when any adjustment is made.

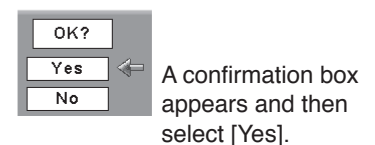
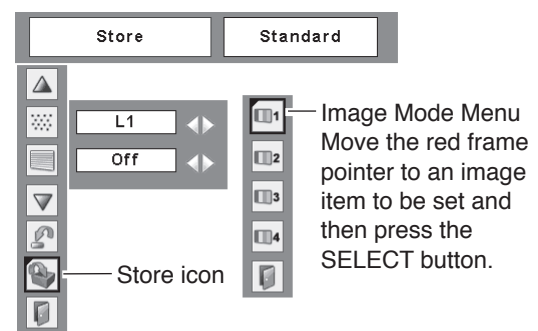

Screen Size Adjustment

This projector has the picture screen resize function, which enables you to customize the image size.

- 1 Press the MENU button to display the On-Screen Menu. Use the Point ◀▶ buttons to move the red frame pointer to the Screen Menu icon.
- 2 Use the Point ▲▼ buttons to move the red frame pointer to the desired function and then press the SELECT button.

Normal

Provide the image at the 4:3 normal video aspect ratio.

Zoom

Pan the horizontal direction of the image and cut the vertical direction of the image to fit the screen size (16:9). Only for 4:3 video aspect ratio signals.

Natural wide

Modify the 4:3 aspect ratio image to fit the screen size (16:9 aspect ratio) by stretching the image to make it look natural.

✓ Note:

- Screen Menu cannot be operated when 720p, 1035i, or 1080i is selected in the AV System Menu (p42).

Custom

Adjust the screen scale and position manually with this function.

Press the SELECT button at Custom and the "Custom" is displayed on the screen for a few seconds and then the Aspect dialog box appears.

- Scale H/V Adjust the Horizontal/Vertical screen scale.
- H&V When set to "On", the aspect ratio is fixed. The "Scale V" appears dimmed and becomes unavailable. Adjust the "Scale H", then the screen scale is automatically modified based on the aspect ratio.
- Position H/V Adjust the Horizontal/Vertical screen position.
- Common Save the adjusted scale to all the inputs. Press the SELECT button at Common to display a confirmation box. To save the scale, press the SELECT button at "Yes". When Custom is selected, the saved scale is used.
- Reset Reset the all adjusted values. Press the SELECT button at Reset to display a confirmation box. To reset, press the SELECT button at "Yes".

Screen Menu

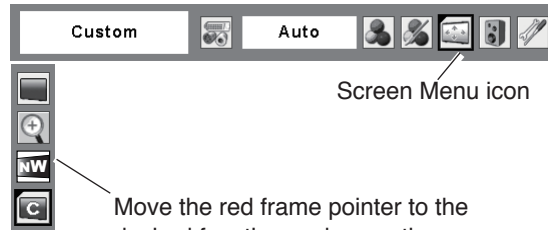

Move the red frame pointer to the desired function and press the SELECT button.

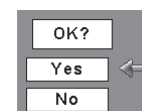
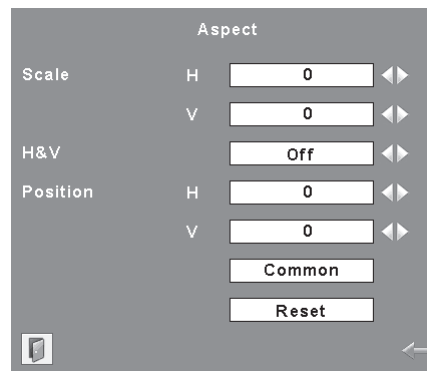

Press the SELECT button at Common or Reset, to display a confirmation box.

✓ Notes:

- When no signal is detected, "Normal" is set automatically and the Aspect dialog box disappears.
- The adjustable range for Scale H/V and Position H/V is limited depending on the input signal.
- "Wide" cannot be operated when 720p, 1035i, or 1080i is selected in the AV System Menu (p.42).

Setting

Setting

This projector has a Setting menu that allows you to set up the other various functions described below.

- 1 Press the MENU button to display the On-Screen Menu. Use the Point ◀▶ buttons to move the red frame pointer to the Setting Menu icon.
- 2 Use the Point ▲▼ buttons to move the red frame pointer to the desired item and then press the SELECT button. The Setting dialog box appears.

Language

The language used in the On-Screen Menu is available in English, German, French, Italian, Spanish, Portuguese, Dutch, Swedish, Finnish, Polish, Hungarian, Romanian, Russian, Chinese, Korean, and Japanese.

Auto setup

This function enables Auto Keystone correction and Auto PC adjustment by pressing the AUTO SETUP/CANCEL button on the top control or the AUTO SET/CANCEL button on the remote control. Settings for those functions can be altered as follows:

Auto PC Adj.

- On. Enables Auto PC Adjustment when pressing the AUTO SET/CANCEL button on the remote control or the AUTO SETUP/CANCEL button on the top control.
- Off. Disables Auto PC Adjustment.

Auto Keystone

- Auto. Always works and corrects keystone distortion according to the projector's tilt.
- Manual . . . Works only when pressing the AUTO SET/CANCEL button on the remote control or the AUTO SETUP/CANCEL button on the top control.
- Off. Disables Auto Keystone.

✓Notes:

- Auto PC Adj. and Auto Keystone cannot be set "Off" at the same time.
- Auto Keystone corrects vertical distortion only, not correct horizontal distortion.
- The Auto Keystone cannot work when Ceiling feature is set "On" in the Setting menu (p.51).
- Perfect correction of the image distortion cannot be ensured with the Auto setup function. If the distortion is not corrected properly by pressing the AUTO SETUP/CANCEL or AUTO SET/CANCEL button, adjust manually by pressing the KEYSTONE button on the remote control or selecting Keystone in the Setting menu (pp.26, 48).
- Fine sync, Total dots, Horizontal and Vertical position of some computers cannot be fully adjusted with the Auto PC Adjustment function. When the image is not provided properly with this operation, manual adjustments are required (pp.34–35).

Setting Menu (Language)

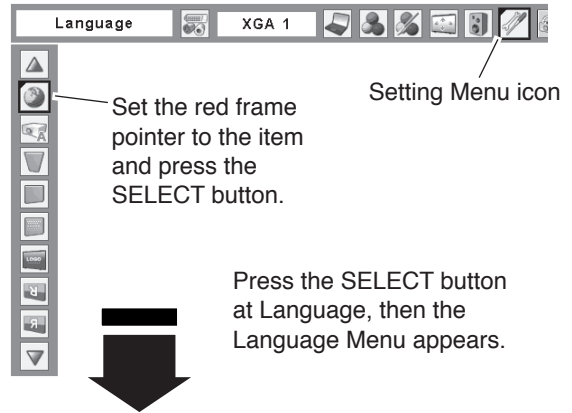

Press the SELECT button at Language, then the Language Menu appears.

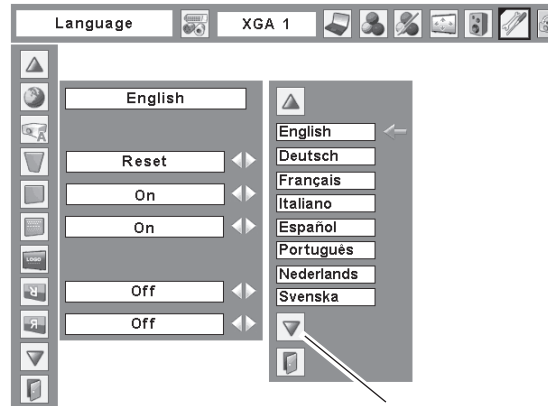

Press the SELECT button here to display the other languages.

Auto setup

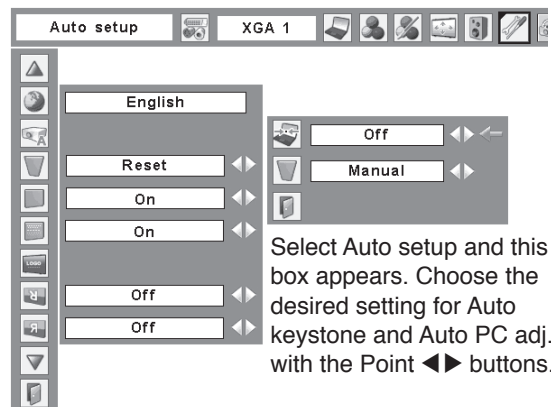

Select Auto setup and this box appears. Choose the desired setting for Auto keystone and Auto PC adj. with the Point ◀▶ buttons.



Keystone

This function is used to store or reset the keystone correction when the AC power cord is unplugged. Use the Point ◀▶ buttons to switch between each option.

- Store Keep the keystone correction even when the AC power cord is unplugged.
- Reset Release the keystone correction when the AC power cord is unplugged.

To correct keystone distortion, press the SELECT button. The “Keystone” appears on the screen. Use the Point ▲▼ buttons to correct keystone distortion (p.26).



Blue back

When this function is “On,” a blue image is displayed while the input signal is not detected.



Display

This function decides whether to display On-Screen Displays.

- On..... Show all the On-Screen displays. Use this function when you want to project images after the lamp becomes bright enough. The factory default setting is in this option.
- Countdown Off..... Show the input image instead of the countdown when turning on the projector. Use this function when you want to project the image as early as possible even when the lamp is not bright enough.
- Off..... Hide the On-Screen Displays except;
 - On-Screen Menu
 - “Power off?” (p.23)
 - “No signal” for Power management (p.52)
 - “Please wait ...”
 - Arrows for the True function in the Screen Menu (p.38)

Keystone

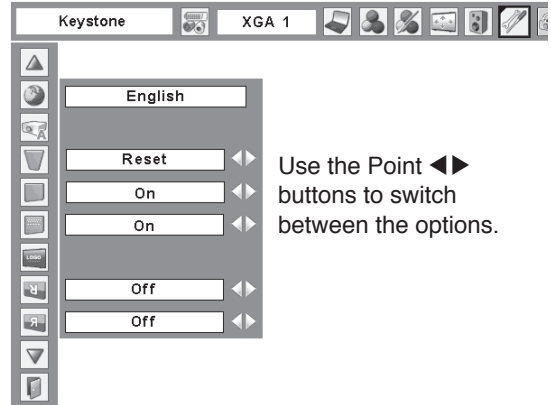

 **Logo (Logo and Logo PIN code lock settings)**

This function allows you to customize the screen logo with Logo select, Capture, and Logo PIN code lock functions.

✓Note:

- When “On” is selected in the Logo PIN code lock function, Logo select and Capture functions cannot be selected.

 **Logo select**

This function decides on the starting-up display from among following options.

- User..... Show the image you captured
- Default..... Show the factory-set logo
- Off..... Show the countdown display only

 **Capture**

This function enables you to capture an image being projected to use it for a starting-up display or interval of presentations.

Select Capture and press the SELECT button. A confirmation box appears and select [Yes] to capture the projected image.

After capturing the projected image, go to the Logo select function and set it to “User”. Then the captured image will be displayed the next time you turn on the projector or when you press the NO SHOW button (see page 29).

To cancel the Capture function, select [No].

✓Notes:

- Before capturing an image, select “Standard” in the Image Select Menu to capture a proper image (pp.36, 43).
- A signal from a computer can be captured up to XGA (1024 x 768). A signal from video equipment can be captured except for 720p, 1035i, and 1080i.
- When capturing the image that has been adjusted by the Keystone function, the adjusted data is automatically reset and the projector captures an image without keystone correction.
- When the Logo PIN code lock function is set to “On,” the Capture function cannot be selected.
- When starting to capture a new image, the previously stored image is cleared even if you cancel the capturing.
- When there is no captured image or it is interrupted while capturing a image, the Capture function cannot be selected, you can only switch between Default and Off.

Logo select

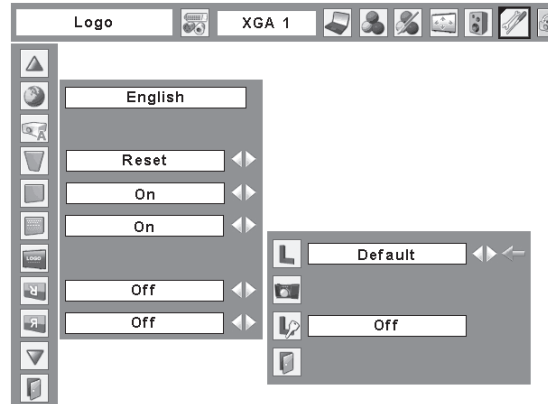

Capture

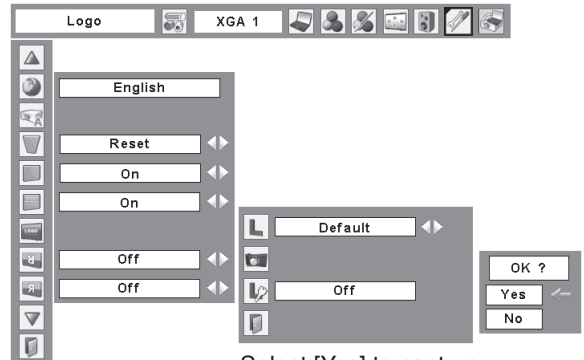

Select [Yes] to capture the projected image.

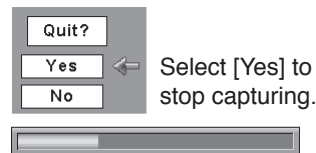



Logo PIN code lock

This function prevents an unauthorized person from changing the screen logo.

- Off..... The screen logo can be changed freely from the Logo Menu (p.49).
- On..... The screen logo cannot be changed without a Logo PIN code.

If you want to change the Logo PIN code lock setting, press the SELECT button and the Logo PIN code dialog box appears. Enter a Logo PIN code by following the steps below. The initial Logo PIN code is set to “4321” at the factory.

Enter a Logo PIN code

Use the Point ▲▼ buttons to enter a number. Press the Point ► button to fix the number and move the red frame pointer to the next box. The number changes to “*.” If you fixed an incorrect number, use the Point ◀ button to move the pointer to the number you want to correct, and then enter the correct number.

Repeat this step to complete entering a four-digit number.

After entering the four-digit number, move the pointer to “Set.” Press the SELECT button so that you can start to operate the projector.

If you entered an incorrect Logo PIN code, “Logo PIN code” and the number (****) will turn red for a moment. Enter the correct Logo PIN code all over again.

Change the Logo PIN code lock setting

Use the Point ◀► buttons to switch On/Off, and then press the Point ▼ button to move the pointer to “Quit.” Press the SELECT button to close the dialog box.

Change the Logo PIN code

Logo PIN code can be changed to your desired four-digit number. Press the Point ▼ button to select “Logo PIN code change” and then press the SELECT button. The New Logo PIN code input dialog box appears. Set a new Logo PIN code.

Be sure to note the new Logo PIN code and keep it at hand. If you lost the number, you could no longer change the Logo PIN code setting. For details on PIN code setting, refer to “PIN code lock” on pages 54–55.

Logo PIN code lock

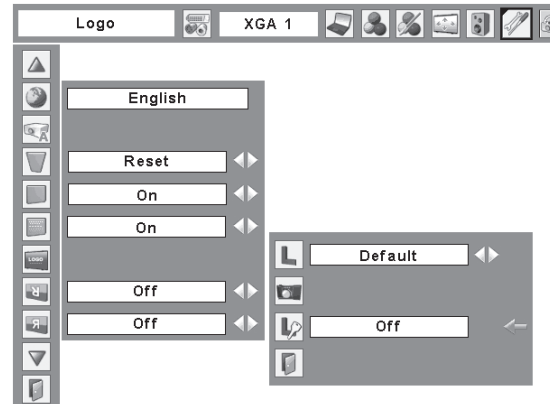

Enter a Logo PIN code

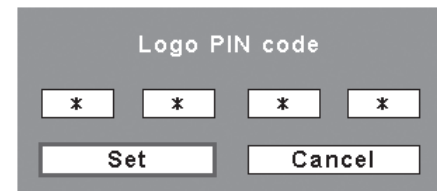

After a correct Logo PIN code is entered, the following dialog box appears.

Change the Logo PIN code lock setting

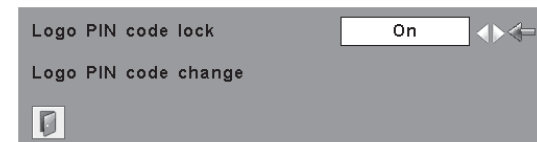

Use the Point ◀► buttons to switch On/Off.

Change the Logo PIN code

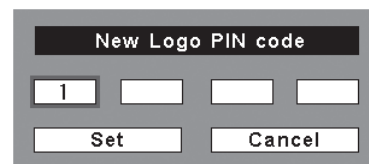

CAUTION:

WHEN YOU HAVE CHANGED THE LOGO PIN CODE, WRITE DOWN THE NEW PIN CODE IN COLUMN OF THE LOGO PIN CODE NO. MEMO ON PAGE 80, AND KEEP IT SECURELY. SHOULD THE LOGO PIN CODE BE LOST OR FORGOTTEN, THE LOGO PIN CODE SETTING CAN NO LONGER BE CHANGED.

Ceiling

When this function is set to “On,” the picture will be top/bottom and left/right reversed. This function is used to project the image from a ceiling-mounted projector.

Rear

When this function is set to “On,” the picture will be left/right reversed. This function is used to project the image from rear of the screen.

Input search

This function detects the input signal automatically. When a signal is found, the search will stop. Use the Point ◀▶ buttons to select one of the following options.

- Off..... Input search will not work.
- On1..... Input search works under the following situation.
 - When pressing the INPUT button on the top control.
 - When pressing the COMPUTER button or VIDEO button on the remote control.
- On2..... Input search works under the following situation.
 - When turning on the projector by pressing the POWER ON/STAND-BY button on the top control or the remote control.
 - When pressing the COMPUTER button or VIDEO button on the remote control.
 - When pressing the INPUT button on the top control.
 - When the current input signal is cut off.*

*If the No show or Freeze function is active, cancel it to activate the Input search. It is also unavailable when On-Screen menu is displayed.

✓Notes:

- While Input search is set to “On1” or “On2,” the status of Input and Lamp are displayed every time the signal is switched.
- Only the last selected input source can be detected.
- If the INPUT button on the top control or COMPUTER or VIDEO buttons on the remote control is pressed during Input search is in progress, Input search will stop and go back to the previous input signal.

Ceiling

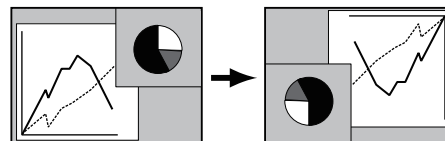

Rear

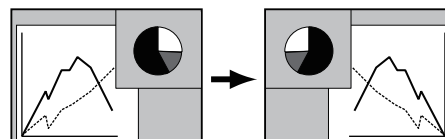



Standby mode

This function is available when operating the projector via network.

Normal..... Supply the power to the network function even after turning off the projector. You can turn on/off the projector via network, modify network environment, and receive an e-mail about projector status while the projector is powered off.

Eco Select "Eco" when you do not use the projector via network. The projector's network function will stop when turning off the projector.

Refer to the owner's manual "Network Set-up and Operation".

✓Note:

- When selecting Normal, the cooling fans may be running depending on the temperature inside the projector even if the projector is turned off.



Power management

For reducing power consumption as well as maintaining the lamp life, the Power management function turns off the projection lamp when the projector is not operated for a certain period.

If the input signal is interrupted and no button is pressed for more than 30 seconds, the timer display with "No signal" appears. It starts the countdown until the lamp is turned off. Use the Point ◀▶ buttons to set the countdown timer.

Select one of the following options:

Ready When the lamp has been fully cooled down, the POWER indicator changes to green blinking. In this condition, the projection lamp will be turned on if the input signal is reconnected or any button on the top control or remote control is pressed.

Shut down..... When the lamp has been fully cooled down, the power will be turned off.

Off..... Power management function is off.

✓Note:

- Factory default is "Ready: 5 min.".

Power management



Time left before Lamp is off.

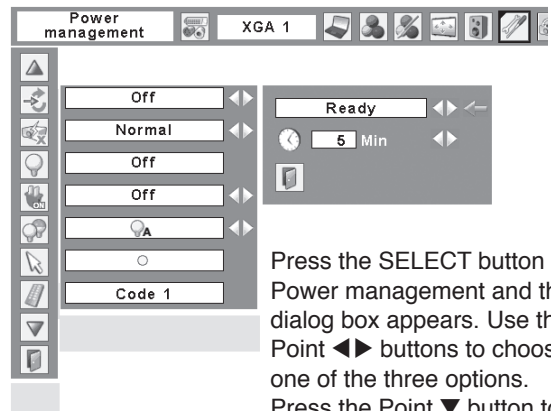

Press the SELECT button at Power management and this dialog box appears. Use the Point ◀▶ buttons to choose one of the three options. Press the Point ▼ button to select the timer, and then use the Point ◀▶ buttons to set timer.



On start

When this function is set to “On,” the projector will be automatically turned on just by connecting the AC power cord to a wall outlet.

✓Note:

- Be sure to turn off the projector properly (see “Turning Off the Projector” on page 23). If the projector is turned off in the incorrect sequence, the On start function does not work properly.



Lamp control

This function allows you to change brightness of the screen.

- Auto The brightness according to the input signal (between High and Eco mode).
- High Brighter than the Normal mode.
- Normal Normal brightness
- Eco Lower brightness reduces the lamp power consumption and extends the lamp life.



Pointer

You can emphasize a part of the projected image with this function. Use the Point ▲▼ buttons to choose either Spotlight or Pointer and press the SELECT button. Then use the Point ◀▶ buttons to select a size of the Spotlight (Large, Middle, or Small) or a pattern of the Pointer (Arrow, Finger, or Dot). See “Pointer Function” on page 14.



Remote control

The eight different remote control codes (Code 1–Code 8) are assigned to the projector; the factory-set, initial code (Code 1) and the other seven codes (Code 2 to Code 8).

The same code should set on both the projector and the remote control. For example, operating the projector in “Code 7”, the remote control code also must be switched to “Code 7”.

To change the code for the projector

Select a remote control code in this Setting Menu.

To change the code for the remote control:

While holding down the MENU button, press the IMAGE button the number of times corresponding to the remote control code for the projector. See “Remote Control Code” on page 15.

Pointer

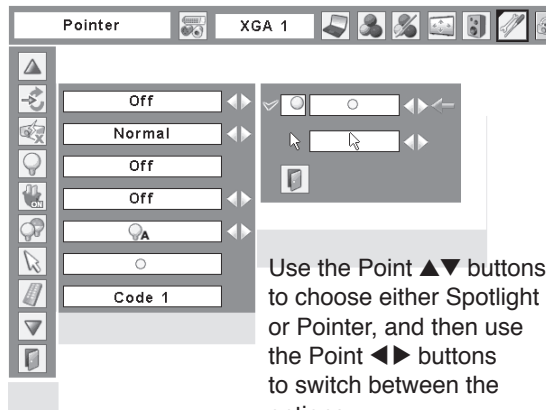

Use the Point ▲▼ buttons to choose either Spotlight or Pointer, and then use the Point ◀▶ buttons to switch between the options.

Remote control

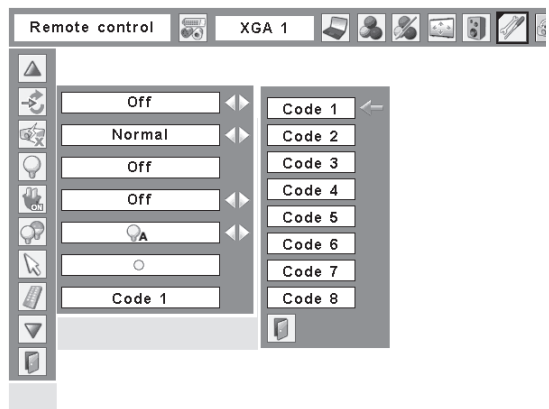



Security (Key lock and PIN code lock, Alarm settings)

This function allows you to use the Key lock and PIN code lock function to set the security for the projector operation.

Key lock

This function locks the top control and remote control buttons to prevent operation by unauthorized persons.

-  Unlocked.
-  Lock the operation of the top control. To unlock, use the remote control.
-  lock the operation of the remote control. To unlock, use the top control.

If the top control accidentally becomes locked and you do not have the remote control nearby or there is something wrong with your remote control, contact the dealer where you purchased the projector or the service center.

PIN code lock

This function prevents the projector from being operated by unauthorized persons and provides the following setting options for security.

- Off..... Unlocked.
- On1..... Enter the PIN code every time turning on the projector.
- On2..... Enter the PIN code to operate the projector once the power cord is disconnected; as long as the AC power cord is connected, the projector can be operated without a PIN code.

Whenever you change the PIN code lock setting or the PIN code (the four-digit number), you are required to enter the PIN code. The “1234” is set as the initial PIN code at the factory.

If you want to change the PIN code lock setting, Press the SELECT button and the PIN code dialog box appears.

Key lock

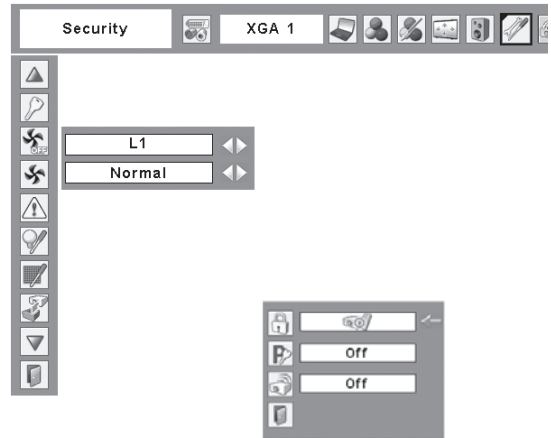

Select Key lock. Use the Point ▲▼ buttons to choose one of the options and select [Yes] to activate it.

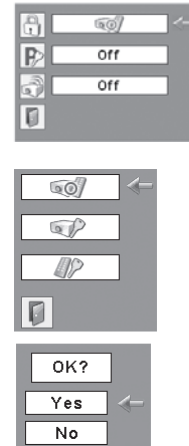

PIN code lock

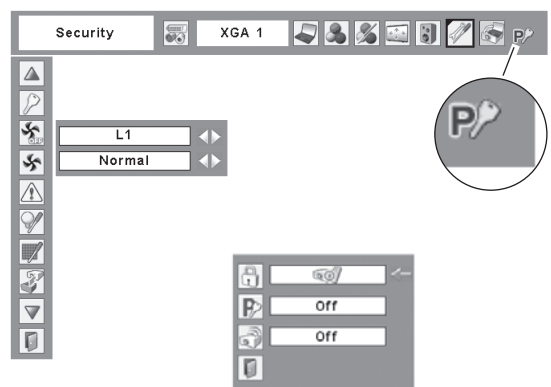

When the projector is locked with a PIN code, the PIN code lock symbol appears on the menu bar.

Enter a PIN code

Use the Point ▲▼ buttons to enter a number. Press the Point ► button to fix the number and move the red frame pointer to the next box. The number changes to “*.” If you fixed an incorrect number, use the Point ◀ button to move the pointer to the number you want to correct, and then enter the correct number.

Repeat this step to complete entering a four-digit number.

After entering the four-digit number, move the pointer to “Set.” Press the SELECT button so that you can start to operate the projector.

If you entered an incorrect PIN code, “PIN code” and the number (****) will turn red for a moment. Enter the correct PIN code all over again.

Change the PIN code lock setting

Use the Point ◀► buttons to select Off, On1, or On2 and then move the pointer to “Quit” with the Point ▼ button. Press the SELECT button to close the dialog box.

Change the PIN code

The PIN code can be changed to your desired four-digit number. Press the Point ▼ button to select “PIN code change” and press the SELECT button. The New PIN code input dialog box appears. Set a new PIN code.

CAUTION:

WHEN YOU HAVE CHANGED THE PIN CODE, WRITE DOWN THE NEW PIN CODE IN COLUMN OF THE PIN CODE NO. MEMO ON PAGE 80, AND KEEP IT SECURELY. IF YOU FORGET YOUR PIN CODE, THE PROJECTOR CAN NO LONGER BE STARTED.



Alarm

This function allows you to configure the Alarm operation. See “How to Use the Antitheft Alarm Function” on pages 58–60.

Enter a PIN code

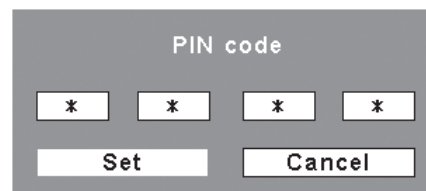

After a correct PIN code is entered, the following dialog box appears.

Change the PIN code lock setting



Use the Point ◀► buttons to switch between the options.

Change the PIN code

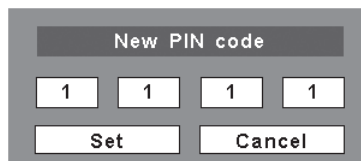



Fan

This function provides the following options in the cooling fans' operation when the projector is turned off (p.23).

- L1 Normal operation
- L2 Slower and lower-sound than the normal operation (L1), but it takes more time to cool the projector down.

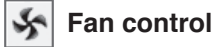

Fan control

Choose the running speed of cooling fans from the following options.

- Normal..... Normal speed
- Max..... Faster than the normal speed.

This function is used to set the cooling fans' operation to the projector's setting environment. Set this function properly in accordance with the projector's installation method.

Otherwise, the cooling fans will not work properly and that causes malfunctions of the projector and decreases the lamp life.

Be sure to set the Fan control in MAX in the setting menu when the projector is inclined between +40 degrees to +140 degrees to the horizontal plane.



Warning log

This function records anomalous operations while the projector is in operation and use it when diagnosing faults. Up to 10 warning logs are displayed with the latest warning message at the top of the list, followed by previous warning messages in chronological order.

✓Note:

- When the Factory default function is executed, all the warning log records will be deleted.



Lamp counter

This function is used to reset the lamp counter.

When the lamp life is left less than 100 hours, the Lamp replacement icon (Fig.1) will appear on the screen, indicating that the end of lamp life is approaching.

When the lamp life is left 0 hour, the Lamp replacement icon (Fig.2) will appear on the screen, indicating that the end of lamp life is reached.

When replacing the projection lamp, reset the lamp counter. See "Resetting the Lamp Counter" on page 66.

✓Note:

- The Lamp replacement icons (Fig.1 and Fig.2) will not appear when the Display function is set to "Off" (p.48), during "Freeze" (p.28), or "No show" (p.29).

Fan

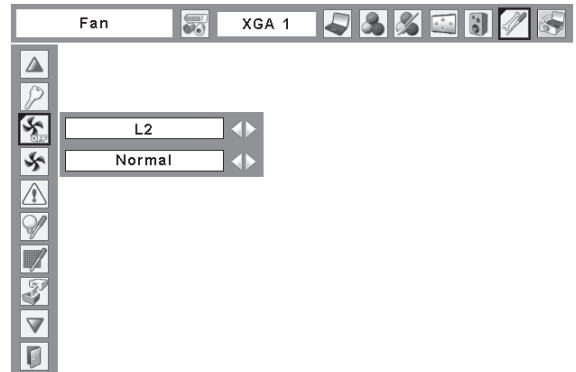

Fan Control Setting

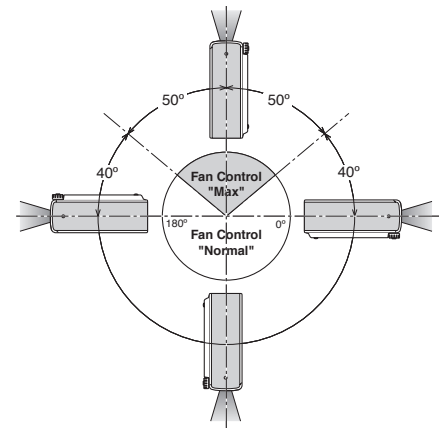

Fig.1 Lamp replacement icon



This icon appears on the screen when the end of lamp life is approaching.

✓Note:

- This icon also appears at turning on and selecting input source.

Fig.2 Lamp replacement icon



This icon appears on the screen when the end of lamp life is reached.

✓Note:

- At turning on, the icon (Fig.2) will appear. At selecting input source, the icon (Fig.1) will appear.

Filter counter

This function is used to set a frequency for the filter cleaning.

When the projector reached a specified time between cleanings, a Filter warning icon appears on the screen, notifying the cleaning is necessary. After cleaning the filter, be sure to select RESET and set the timer. The Filter warning icon will not turn off until the filter counter is reset.

For details about resetting the timer, refer to “Resetting the Filter Counter” on page 63.

Filter counter

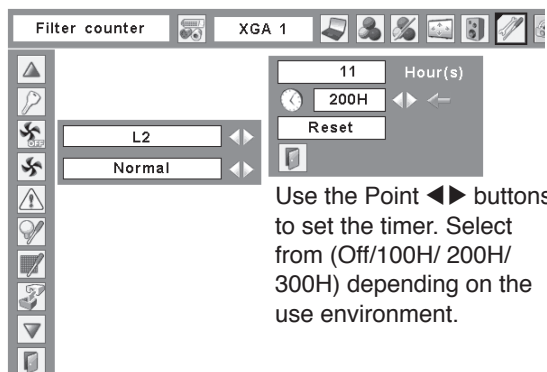

Use the Point ◀▶ buttons to set the timer. Select from (Off/100H/ 200H/ 300H) depending on the use environment.

Fig.3 Filter warning icon



Filter warning icon appears on the screen at a set time.

✓Note:

- This icon also appears at turning on..

Fig.4 Filter warning icon



✓Notes:

- At selecting input source, the icon (Fig.4) will appear..
- The Filter warning icons (Fig.3 and Fig.4) will not appear when the Display function is set to “Off” (p.48), during “Freeze”(p.28), or “No show” (p.29).

Factory default

This function returns all setting values except for the user logo, PIN code lock, Logo PIN code lock, lamp counter, and filter counter to the factory default settings.

Quit

Exit the Setting Menu.

Factory default

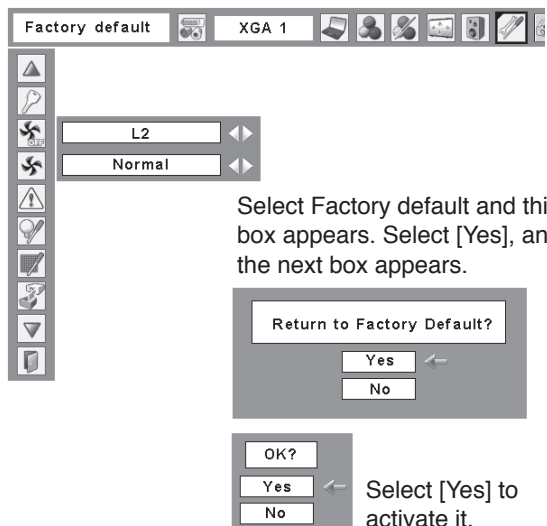

Select Factory default and this box appears. Select [Yes], and the next box appears.

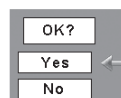
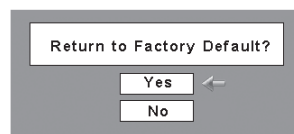

Select [Yes] to activate it.

Antitheft Alarm Function

How to Use the Antitheft Alarm Function

Antitheft alarm function is provided to prevent the projector from being stolen. When this function is set to “On,” the alarm rings as an unauthorized person tries to move the projector.

To activate the Alarm function for the first time after purchase, you must turn on the power once.

✓Notes:

- This function is not a guarantee against stealing.
- The alarm does not ring while the AC power cord is connected to an outlet even if the projector detects vibrations.
- The alarm will stop, as the AC power cord is connected to an outlet, except when the battery cover is open.
- Pressing the buttons is always accompanied by a sound. If no sound is produced after pressing a button, you need to press it again.

The Alarm function is operated by a built-in rechargeable battery. The alarm will not work properly if the battery is not charged enough. See page 60 for details.

Set and release the Antitheft alarm function

The Alarm setting and release and PIN Code change can be made without an AC power connection.

Set the alarm

Press the F button three times to turn the alarm function on. The ALARM indicator blinks for a few seconds and the projector enters the warning mode. (If the battery is not charged enough for the alarm function to operate normally, it beeps and the Alarm indicator will blink red every 20 seconds.)

During the Antitheft alarm function is on, the projector emits a low-pitched sound when it detects vibration.

When the projector does not detect vibration for a few seconds after the sound, it goes back to the warning mode.

When the projector detects more vibrations after the low-pitched sound, the alarm starts ringing.

The Alarm operating configuration (Battery charge, Alarm volume, Sensitivity, and Ringing time) can be selected in the menu. See page 59.

✓Notes:

- You can test the alarm sound without setting the alarm function. Press and hold the F button, then the alarm starts ringing. The duration of the alarm sound is the same as the “Ringing Time” setting (p.59).
- If you want to stop the alarm while it is ringing, insert the AC power cord to an outlet or press the F button and enter the four-digit PIN code number.

Release the alarm setting

Press the F button and enter the four-digit PIN code number within about 10 seconds. (The default PIN code is set to “1111.”) When the alarm is released, you will hear a high-pitched confirmation sound.

When you enter an incorrect PIN code, you will hear a low-pitched sound. If you enter an incorrect PIN code three times in a row, the alarm will start ringing.

Top Control

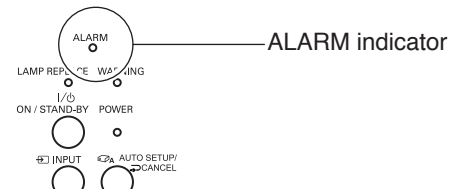

Rear Terminal

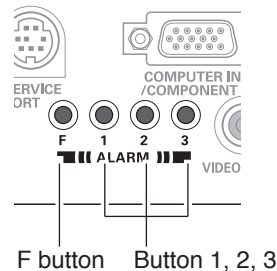

Other settings

Change the PIN code

- 1 Press the F button and enter the four-digit PIN code number within about 10 seconds. The ALARM indicator blinks red for a few seconds and a high-pitched confirmation sound is produced.
- 2 While the indicator is blinking, enter a new PIN code, then you will hear a high-pitched confirmation sound and the ALARM indicator is turned off.

When you enter an incorrect PIN code, you will hear a low-pitched sound. If you enter incorrect PIN code three times in a row, the alarm will start ringing.

The PIN code for the Antitheft alarm function is a combination of 1, 2, or 3. Use the buttons 1, 2, and 3 to enter the PIN code. The default PIN code is "1111."

Reset the settings

Select "Factory default" in the Setting menu to reset the settings for the Antitheft alarm function.

✓Note:

- This is effective only when the Antitheft alarm setting is released.

Alarm operating configuration

The Alarm operating configuration can be changed when the Antitheft alarm function is set to "Off." See page 58 for setting or releasing this function.

Press the SELECT button at Alarm icon in the Setting Menu to display the Alarm setting dialog box. Use the Point ▲▼ buttons to select the desired option; use the Point ◀▶ buttons to set the selected option.

Battery charge

See the next page for details.

Alarm volume

Small, Medium, Large

Sensitivity

- Low Less sensitive
- Medium Normal sensitivity
- High Highly sensitive (default)

Ringling time

- 10 seconds Rings about 10 seconds (default).
- 60 seconds Rings about 60 seconds.
- Long time Rings until the end of the battery life.

CAUTION:

WHEN YOU HAVE CHANGED THE PIN CODE, WRITE DOWN THE NEW PIN CODE IN COLUMN OF THE PIN CODE NO. MEMO ON PAGE 80, AND KEEP IT SECURELY. IF YOU FORGET YOUR PIN CODE, SOME SETTINGS OF THE ANTITHEFT ALARM FUNCTION CAN NO LONGER BE CHANGED.

Top Control



Rear Terminal

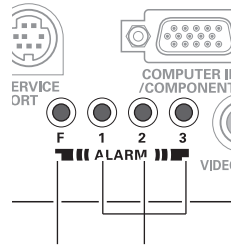

F button Button 1, 2, 3

Alarm

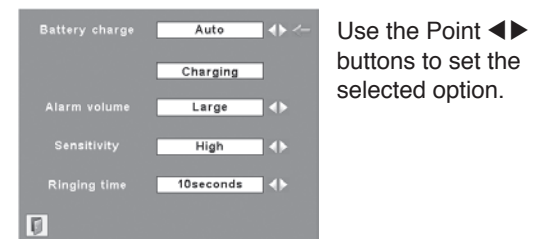
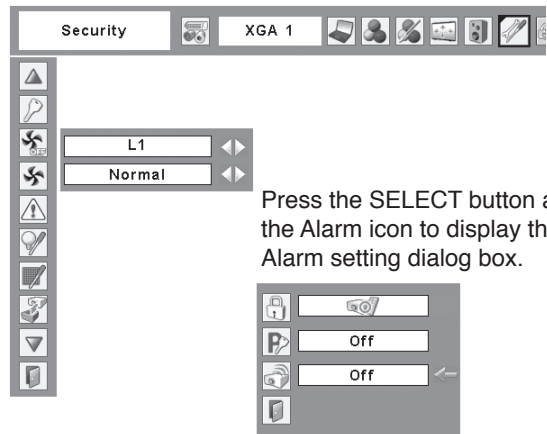

✓Notes:

- The Alarm icon appears dimmed and can be unavailable when the Antitheft alarm function is set to "On" or if the battery is not installed, discharged, or coming to the end of its life.
- When the "Security" is selected in the Setting menu, the Antitheft alarm setting buttons can be unavailable.
- When selecting "Long time" option in the Ringing time, the duration of alarm sounding differs depending on the battery life.

Antitheft Alarm Function

Charge the built-in batteries

Set the Battery charge option in the Alarm setting menu to "Auto." The default setting is "Auto."

As long as the AC power cord is connected and this option is set to "Auto," the built-in battery for Alarm function is being charged at all times. While charging the battery, "Charging" is displayed in the menu.

The "Charging" appears dimmed when the battery is fully charged or the Battery charge option is set to "Off," or if charging malfunction occurs. Set the option to "Off" when not using the Alarm function. This can save the power and battery life.

Replace the rechargeable batteries

Use only the specified battery for this projector. Using other types of battery may cause accident or fire hazard.

Replacement Battery: SANYO Ni-MH BATTERY PACK
Part No. 645 089 8587

How to replace the rechargeable batteries

- 1 Unplug the AC power cord from a wall outlet.
- 2 Set the Alarm function to "Off" (see page 58). If it is not released, the alarm will start ringing when you try to remove the rechargeable battery cover.
- 3 Remove the screw from the rechargeable battery cover and open the cover.
- 4 Pull out the battery connector and remove the battery.
- 5 Install new battery and plug the connector into the socket.
Note: The battery connector has polarity. Observe battery polarity when installing.
- 6 Put back the battery cover and secure it with the screw.
Caution: Tighten the screw securely. If you fail to do so, the alarm will not operate. Do not use any other screws. This may cause damage to the projector.

✓Note:

- The PIN code and settings you have changed are effective even after the battery is changed.
- Unplug the battery connector if you carry your projector frequently and use the carrying case. If you do not unplug the battery connector, the alarm may be triggered when the Alarm buttons are accidentally pressed inside the carrying case.

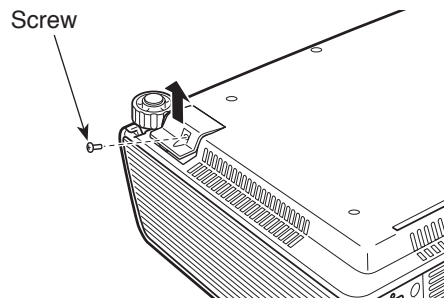

Remove the screw and open the battery cover.

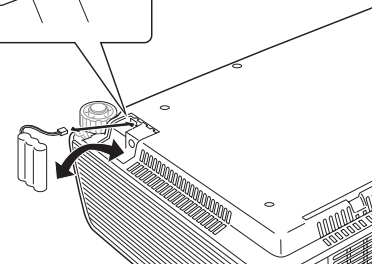
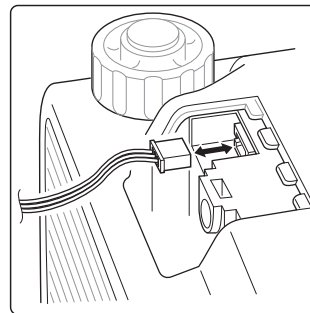

Install the battery, then put back the battery cover and secure it with the screw.



SAFETY PRECAUTIONS FOR SANYO Ni-MH BATTERY PACK

Observe the following precautions when handling the built-in battery pack of the projector:

- MAKE SURE THAT THE BATTERY PACK IS INSTALLED IN THE PROJECTOR WHEN RECHARGING. USING THE CHARGERS OTHER THAN THE PROJECTOR MAY CAUSE EXPLOSION OR A FIRE.
- The rechargeable battery pack is for use exclusively with this projector. Do not use in other products or this may cause accident.
- Do not throw the battery into fire or heat it. Doing so may cause an explosion or fire.
- Never attempt to disassemble, modify, reconstruct, or solder lead wires directly on to the battery.
- Do not drop or subject to strong forces. Doing so may cause the battery to leak fluid or explode.
- Do not expose to direct sunlight or high temperatures. This may degrade battery performance or cause leakage.
- Avoid contact with water or liquid. Exposure to water or liquid could result in battery corrosion or damage.
- Keep out of reach of children. They may accidentally swallow the battery.
- Do not short-circuit battery terminals with metal objects. Do not store with metal objects or in a metal case.
- The rechargeable battery pack has a limited number of charge cycles and eventually need to be replaced. If it can no longer be recharged, stop charging immediately and replace it with new one.
- Recharge the battery in a place where the temperature is always between **32°F to 104°F (0°C to 40°C)**. Charging in the temperature out of this range may result in fluid leak, heat generation, or shortening battery life.
- If you do not use the projector or the Antitheft alarm function for a long period of time, remove the battery from the projector and store it in a place where the temperature is always between **-4°F to 86°F (-20°C to 30°C)**.
- If a battery leaks and fluid comes in contact with skin, this may cause skin irritation. Flush the affected area thoroughly with water.
- If a battery leaks and fluid gets in contact with eyes, wash your eyes with water immediately and seek medical attention.
- Dispose of used batteries according to your local disposal rule and guidelines.



回收標誌

Maintenance and Cleaning

Warning Indicator

The WARNING indicator shows the state of the function which protects the projector. Check the state of the WARNING indicator and the POWER indicator to take proper maintenance.

The projector is shut down and the WARNING indicator is blinking red.

When the temperature inside the projector reaches a certain level, the projector will be automatically shut down to protect the inside of the projector. The POWER indicator is blinking while the projector is being cooled down. When the projector has cooled down enough (to its normal operating temperature), it can be turned on again by pressing the POWER ON/STAND-BY button.

✓ **Note:**

- The WARNING indicator continues to blink even after the temperature inside the projector returns to normal. When the projector is turned on again, the WARNING indicator stops blinking.

Then check the matters below:

- Did you provide appropriate space for the projector to be ventilated? Check the installing condition to see if the air vents of the projector are not blocked.
- Has the projector been installed near an Air-Conditioning/ Heating Duct or Vent? Move the installation of the projector away from the duct or vent.
- Is the filter clean? Clean the filter periodically.

The projector is shut down and the WARNING indicator lights red.

When the projector detects an abnormal condition, it is automatically shut down to protect the inside of the projector and the WARNING indicator lights red. In this case, unplug the AC power cord and reconnect it, and then turn the projector on once again to verify operation. If the projector cannot be turned on and the WARNING indicator still lights red, unplug the AC power cord and contact the service station.



CAUTION

DO NOT LEAVE THE PROJECTOR WITH THE AC POWER CORD CONNECTED UNDER AN ABNORMAL CONDITION. IT MAY RESULT IN FIRE OR ELECTRIC SHOCK.

Top Control

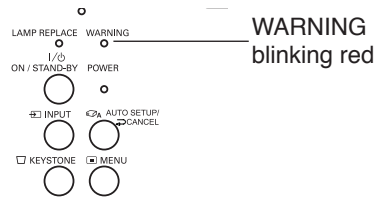

Top Control

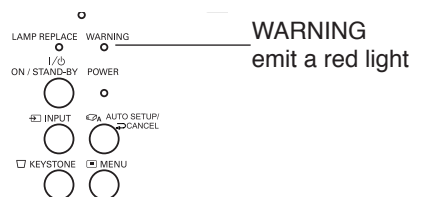

Cleaning the Filter

Filter prevents dust from accumulating on the optical elements inside the projector. Should the filter become clogged with dust particles, it will reduce cooling fans' effectiveness and may result in internal heat buildup and adversely affect the life of the projector. If a "Filter warning" icon appears on the screen, clean the filter immediately. Clean the filter by following the steps below.

- 1 Turn off the projector, and unplug the AC power cord from the AC outlet.
- 2 Turn the projector over and remove the filter by pulling the latches upward.
- 3 Gently clean the filter by using a brush or rinse it softly.
- 4 When rinsing the filter, dry it well. Replace the filter properly. Make sure that the filter is fully inserted to the projector.



CAUTION

Do not operate the projector with the filter removed. Dust may accumulate on the optical elements degrading picture quality. Do not put anything into the air vents. Doing so may result in malfunction of the projector.

RECOMMENDATION

We recommend avoiding dusty/smoky environments when you operate the projector. Usage in these environments may cause poor image quality.

When using the projector under dusty or smoky conditions, dust may accumulate on a lens, LCD panels, or optical elements inside the projector degrading the quality of a projected image. When the symptoms above are noticed, contact your authorized dealer or service station for proper cleaning.

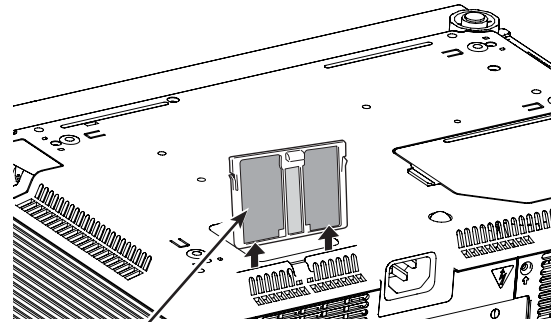

Filter
Pull up and remove.

✓Note:

- When reinserting this filter, be sure that the slit part is facing the outer side.

Resetting the Filter Counter

Be sure to reset the Filter counter after cleaning or replacing the filters.

- 1 Press the MENU button to display the On-Screen Menu. Use the Point ◀▶ buttons to move the red frame pointer to the Setting Menu icon.
- 2 Use the Point ▲▼ buttons to move the red frame pointer to Filter counter and then press the SELECT button. A dialog box appears showing the total accumulated time of the filter use, a timer setting option, and the reset option. Select Reset and the "Filter counter Reset?" appears. Select [Yes] to continue.
- 3 Another confirmation dialog box appears, select [Yes] to reset the Filter counter.

Filter counter

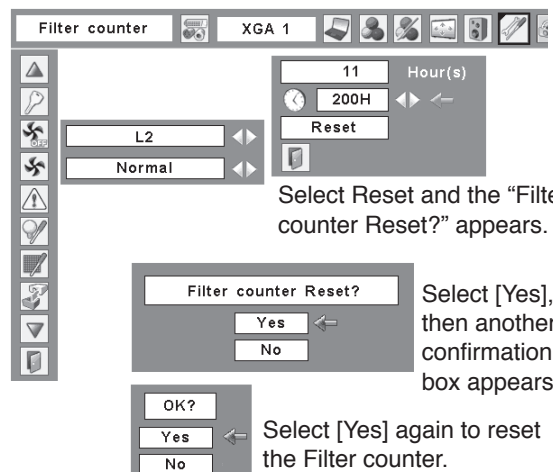

Select Reset and the "Filter counter Reset?" appears.

Select [Yes], then another confirmation box appears.

Select [Yes] again to reset the Filter counter.

Maintenance and Cleaning

Attaching the Lens Cover

When moving this projector or while not using it over an extended period of time, replace the lens cover.

Attach the lens cover according to the following procedures.

- 1 Pass the string through a hole of the lens cover.
- 2 Turn over the projector and remove the screw with a screwdriver.
- 3 Attach the string with lens cover to a hole at the bottom of the projector and secure it with a screw.

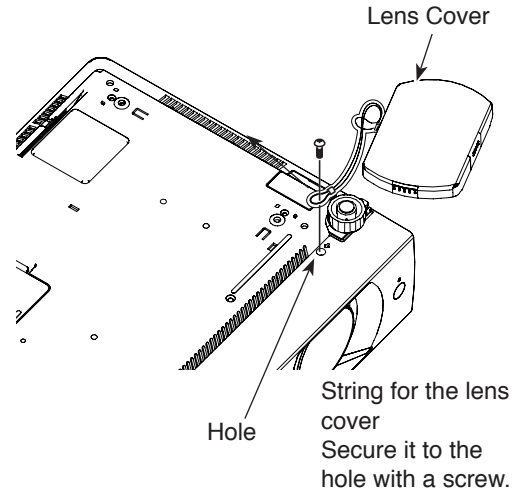

Cleaning the Projection Lens

Unplug the AC power cord before cleaning.

Gently wipe the projection lens with a cleaning cloth that contains a small amount of non-abrasive camera lens cleaner, or use a lens cleaning paper or commercially available air blower to clean the lens.

Avoid using an excessive amount of cleaner. Abrasive cleaners, solvents, or other harsh chemicals might scratch the surface of the lens.

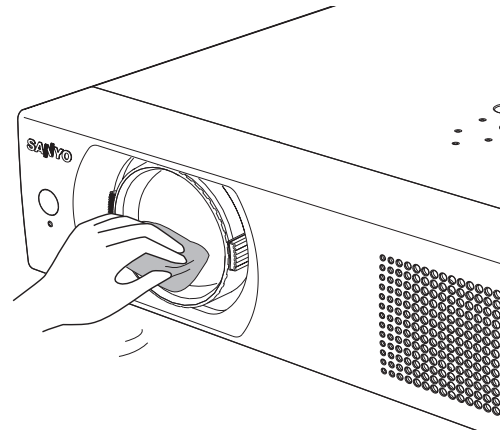

Cleaning the Projector Cabinet

Unplug the AC power cord before cleaning.

Gently wipe the projector body with a soft dry cleaning cloth. When the cabinet is heavily soiled, use a small amount of mild detergent and finish with a soft dry cleaning cloth. Avoid using an excessive amount of cleaner. Abrasive cleaners, solvents, or other harsh chemicals might scratch the surface of the cabinet.

When the projector is not in use, put the projector in an appropriate carrying case to protect it from dust and scratches.

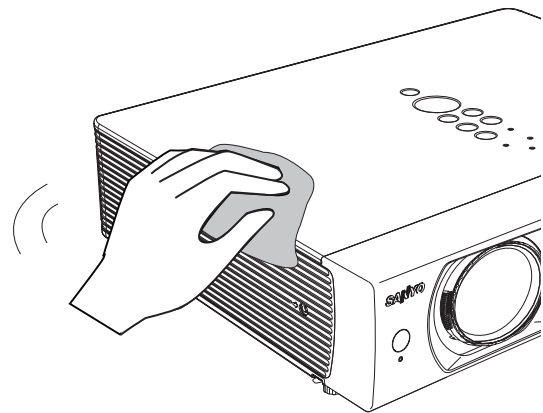

Lamp Replacement

When the projection lamp of the projector reaches its end of life, the Lamp replacement icon appears on the screen and LAMP REPLACE indicator lights yellow. Replace the lamp with a new one promptly. The timing when the LAMP REPLACE indicator should light is depending on the lamp mode.

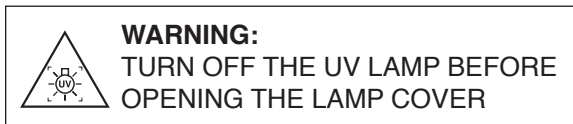

Top Control

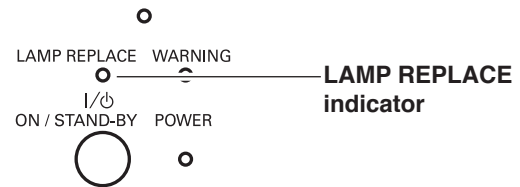

Lamp replacement



Lamp replacement icon

✓Note:

- The Lamp replacement icon will not appear when the Display function is set to "Off" (p.48), during "Freeze" (p.28), or "No show" (p.29).



CAUTION

Allow a projector to cool for at least 45 minutes before you open the Lamp cover. The inside of the projector can become very hot.



CAUTION

For continued safety, replace with a lamp of the same type. Do not drop a lamp or touch a glass bulb! The glass can shatter and may cause injury.

Follow these steps to replace the lamp.

- 1 Turn off the projector and unplug the AC power cord. Let the projector cool for at least 45 minutes.
- 2 Remove the screw and open the lamp cover.
- 3 Remove the two (2) screws that secure the lamp. Lift the lamp out of the projector by using the handle.
- 4 Replace the lamp with a new one and secure the two (2) screws. Make sure that the lamp is set properly. Close the lamp cover and secure the screw.
- 5 Connect the AC power cord to the projector and turn on the projector.
- 6 **Reset the lamp counter.**
See "Resetting the Lamp Counter" on the next page.

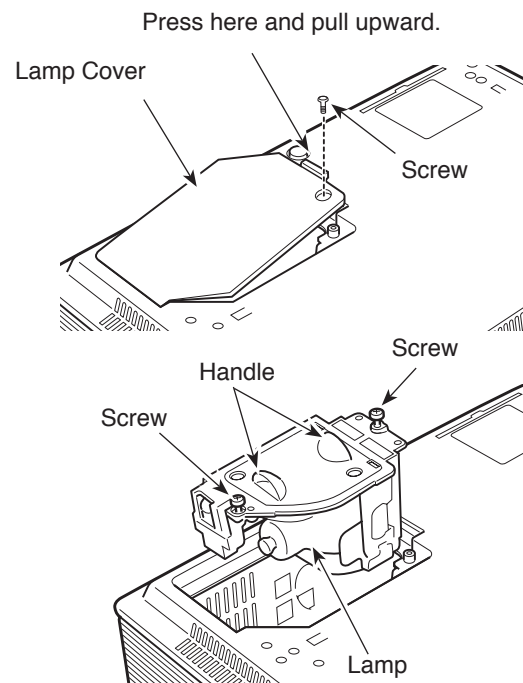

ORDER REPLACEMENT LAMP

Replacement lamp can be ordered through your dealer. When ordering a projection lamp, give the following information to the dealer.

- **Model No. of your projector** : PLC-WXU30
- **Replacement Lamp Type No.** : POA-LMP111
(Service Parts No. 610 333 9740)

Resetting the Lamp Counter

Be sure to reset the Lamp counter after the lamp is replaced. When the Lamp counter is reset, the LAMP REPLACE indicator stops lighting and the Lamp replacement icon disappears.

- 1 Press the MENU button to display the On-Screen Menu. Use the Point ◀▶ buttons to move the red frame pointer to the Setting Menu icon.
- 2 Use the Point ▲▼ buttons to move the red frame pointer to Lamp counter and then press the SELECT button. A dialog box appears showing the total accumulated time of the lamp usage and the reset option. Select Reset and the “Lamp replacement counter Reset?” appears. Select [Yes] to continue.
- 3 Another confirmation dialog box appears, select [Yes] to reset the Lamp counter.

✓**Note:**

- Do not reset the Lamp counter without implementing lamp replacement. Be sure to reset the Lamp counter only after replacing the lamp.

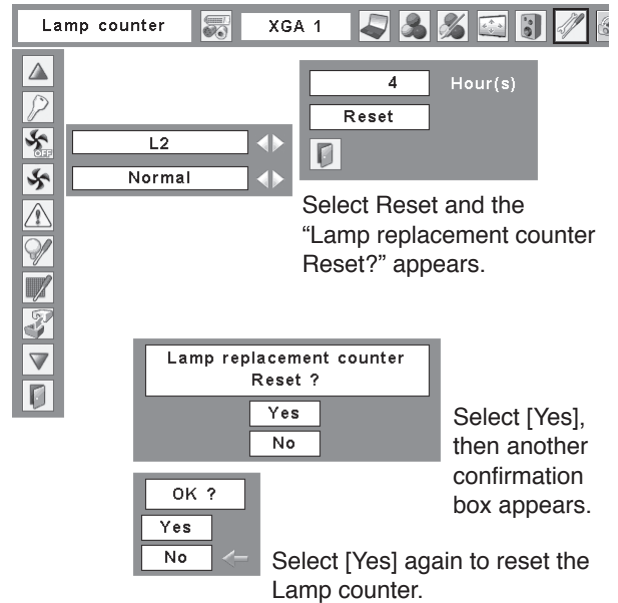

LAMP HANDLING PRECAUTIONS

This projector uses a high-pressure lamp which must be handled carefully and properly. Improper handling may result in accidents, injury, or create a fire hazard.

- Lamp life may differ from lamp to lamp and according to the environment of use. There is no guarantee of the same life for each lamp. Some lamps may fail or terminate their life in a shorter period of time than other similar lamps.
- If the projector indicates that the lamp should be replaced, i.e., if the LAMP REPLACE indicator lights up, replace the lamp with a new one IMMEDIATELY after the projector has cooled down. (Follow carefully the instructions in the Lamp Replacement section of this manual.) Continuous use of the lamp with the LAMP REPLACE indicator lighted may increase the risk of lamp explosion.
- A Lamp may explode as a result of vibration, shock or degradation as a result of hours of use as its lifetime draws to an end. Risk of explosion may differ according to the environment or conditions in which the projector and lamp are being used.

IF A LAMP EXPLODES, THE FOLLOWING SAFETY PRECAUTIONS SHOULD BE TAKEN.

If a lamp explodes, disconnect the projector's AC plug from the AC outlet immediately. Contact an authorized service station for a checkup of the unit and replacement of the lamp. Additionally, check carefully to ensure that there are no broken shards or pieces of glass around the projector or coming out from the cooling air circulation holes. Any broken shards found should be cleaned up carefully. No one should check the inside of the projector except those who are authorized trained technicians and who are familiar with projector service. Inappropriate attempts to service the unit by anyone, especially those who are not appropriately trained to do so, may result in an accident or injury caused by pieces of broken glass.

Appendix

Troubleshooting

Before calling your dealer or service center for assistance, check the items below once again.

- Make sure you have properly connected the projector to peripheral equipment as described on pages 19-21.
- Make sure all equipment is connected to AC outlet and the power is turned on.
- When the projector does not project an image from the connected computer, restart the computer.

Problem:	Solutions
No power	<ul style="list-style-type: none">– Plug the power cord of the projector into the AC outlet.– See if the POWER indicator lights red.– Wait until the POWER indicator stops blinking to turn on the projector again. The projector can be turned on after the POWER indicator turns red. See page 22.– Check the WARNING indicator. If the WARNING indicator lights red, projector cannot be turned on. See page 62.– Check the projection lamp. See page 65.– Unlock the Key lock function for the projector. See page 54.
The initial display is not shown.	<ul style="list-style-type: none">– Make sure "User" or "Countdown off" are not chosen at display function.(see page 48)
The initial display is not same as the default set.	<ul style="list-style-type: none">– Make sure "User" or "Countdown off" are not chosen at Logo (select) function.(see page 48)
Input signal switches automatically. (or does not switch automatically)	<ul style="list-style-type: none">– Make sure Input search function is adjusted properly. See page 51.
When the projector is on and you press the input button, an icon other than the Lamp mode icon appears.	<ul style="list-style-type: none">– That is the Filter warning icon. Refer to page 57.
An icon other than Input mode or Lamp mode icon appears.	<ul style="list-style-type: none">– That is the Lamp replacement icon or the Filter warning icon. See page 56 or 57.
Image is out of focus.	<ul style="list-style-type: none">– Adjust focus of the projector. See page 26.– Provide proper distance between the projector and the projection screen. See page 17.– Check the projection lens to see if it needs cleaning. See page 64.– Moving the projector from a cool to warm place may result in moisture condensation on the projection lens. In such cases, leave the projector off and wait until condensation evaporates.
Image is Left/Right reversed. Image is Top/Bottom reversed.	<ul style="list-style-type: none">– Check the Ceiling/Rear function. See page 51.– Check the Top/Bottom function. See page 51.
Picture is not bright enough.	<ul style="list-style-type: none">– Check if the "Contrast" or "Brightness" are adjusted properly.(see page 37,44)– Check if "Image mode" is selected properly.(see page 36,43)– Check the lamp control function.(see page 28)– Check the LAMP REPLACE indicator. If it lights, the end of lamp life is approaching. Replace the lamp with a new one promptly.(see page 65)

No image	<ul style="list-style-type: none">– Check the connection between your computer or video equipment and the projector. See pages 19-21.– See if the input signal is correctly output from your computer. Some laptop computers may need to change the setting for monitor output when connecting to a projector. See your computer's instruction manual for the setting.– It takes about 30 seconds to display an image after turning on the projector. See page 22.– Check the Input signal, color system, video system or computer system mode.– Make sure the temperature is not out of the specified Operating Temperature (41°F–95°F [5°C–35°C]).– When "No Show" is operating, the image cannot be displayed. Press the NO SHOW button or any other button on the remote control.
No sound	<ul style="list-style-type: none">– Check the audio cable connection from audio input source.– Adjust the audio source.– Press the Volume + button. See page 27.– Press the Mute button. See page 27.– When the AUDIO OUT is plugged-in, the projector's built-in speaker is not available– Is the image projected? You will hear the sound only when the image is projected.
The color is strange.	<ul style="list-style-type: none">– Check the Input signal, color system, video system or computer system mode.– Make sure the "Blackboard" is not selected on Image select menu. (see page 36,43)
Some displays are not seen during the operation.	<ul style="list-style-type: none">– Check the Display function. See page 48.
Auto PC adjustment function does not work.	<ul style="list-style-type: none">– Check the Input signal. Auto PC function can not work when 480p,575p,720p,480i,575i,1035i or 1080i is selected or when the digital signal is input into DVI terminal. (see Page 34)– The icon is not available in grayout when the digital signal is input.
The setting does not remain after turning off power.	<ul style="list-style-type: none">– Make sure you selected "Store" after adjusting setting. Some settings can not be stored if not registered with "Store". (see page 45)
Power management does work.	<ul style="list-style-type: none">– Power management function can not work while "Freeze" or "No Show" function is running. (see page 52)
Capture function does not work.	<ul style="list-style-type: none">– Check the connection and the input signal to see if there is signal.
Auto setup does not work properly.	<ul style="list-style-type: none">– Make sure "Off" is not selected at the Auto setup function. (see page 47)– Make sure "On" is not selected at the Ceiling function. (see page 51)
Auto keystone function does not work even when the projector is tipped.	<ul style="list-style-type: none">– Make sure the Auto keystone function is not set to "Manual". Press the AUTO SET UP button on the top control. (see page 26,47)

The image is distorted or runs off.	<ul style="list-style-type: none"> – Check "PC adjustment" menu or "Screen" menu and adjust them. (page 33-34, 38-39)
PIN code dialog box appears at start-up.	<ul style="list-style-type: none"> – PIN code lock is being set. Enter a PIN code (the "1234" or numbers you have set). See pages 22, 54–55.
Page Up/Down function does not work.	<ul style="list-style-type: none"> – Make sure your computer is connected to the projector with USB cable.(see page 19) – Check cable connection between the projector and your computer. (see page 19)
The Remote Control does not work.	<ul style="list-style-type: none"> – Check the batteries. – Make sure no obstruction is between the projector and remote control. – Make sure you are not too far from the projector when using the remote control. Maximum operating range is 16.4'(5 m). – Wireless reomete control does not work when the remote control cable is connected to the projector.(see page 13) – Make sure the code of the remote control is conformed to the projector's code. See page 53. – Unlock the Key lock function for the remote control function. See page 54. – Check RESET/ON/ALL-OFF switch on the remote control is set to "ON". See page 15.
Alarm does not stop ringing.	<ul style="list-style-type: none"> – Connect the AC power cord to the AC outlet. (Alarm will not stop ringing when the alarm goes off while trying to remove the rechargeable battery cover.)
Indicator blinks or lights.	<ul style="list-style-type: none"> – Chek the status of the projector with referring to "Indicators and projector Condition".(see page 73) – In the case of the ALARM indicator blinks, check the setting.(see page 58)
Wireless Mouse function does not work.	<ul style="list-style-type: none"> – Check the connection between a projector and your computer. – Check the mouse setting on you computer. – Make sure the mouse driver is installed on your computer, otherwise, the remote control can not be used as a wireless mouse. – Make sure the signal is from the computer, otherwise, the remote control can not be used as a wireless mouse. – Turn on the projector before turning on the computer.
The exclamation mark appears on the screen.	<ul style="list-style-type: none"> – Your operation is invalid. Operate correctly.
Top control does not work.	<ul style="list-style-type: none"> – The top control is not available if the top cotrol is locked at "Key lock" under "Security" of SETTING section. Please check "SETTING" section on page 54.
Uable to unlock the Logo PIN code lock, Security key lock or Security PIN code lock.	<ul style="list-style-type: none"> – Contact the dealer where you purchased the projector or the service center.

Warning mode is not turned on.

- If you cannot hear the bleeping sound when you press the Alarm buttons, you are not pressing the buttons correctly. Try to set the Alarm setting again.

WARNING :

High voltages are used to operate this projector. Do not attempt to open the cabinet.

If problems still persist after following all operating instructions, contact the dealer where you purchased the projector or the service center. Specify the model number and explain about the problem. We will advise you how to obtain service.

 The CE Mark is a Directive conformity mark of the European Community (EC).



This symbol on the nameplate means the product is Listed by Underwriters Laboratories Inc. It is designed and manufactured to meet rigid U.L. safety standards against risk of fire, casualty and electrical hazards.

Menu Tree

Computer Input/Video Input

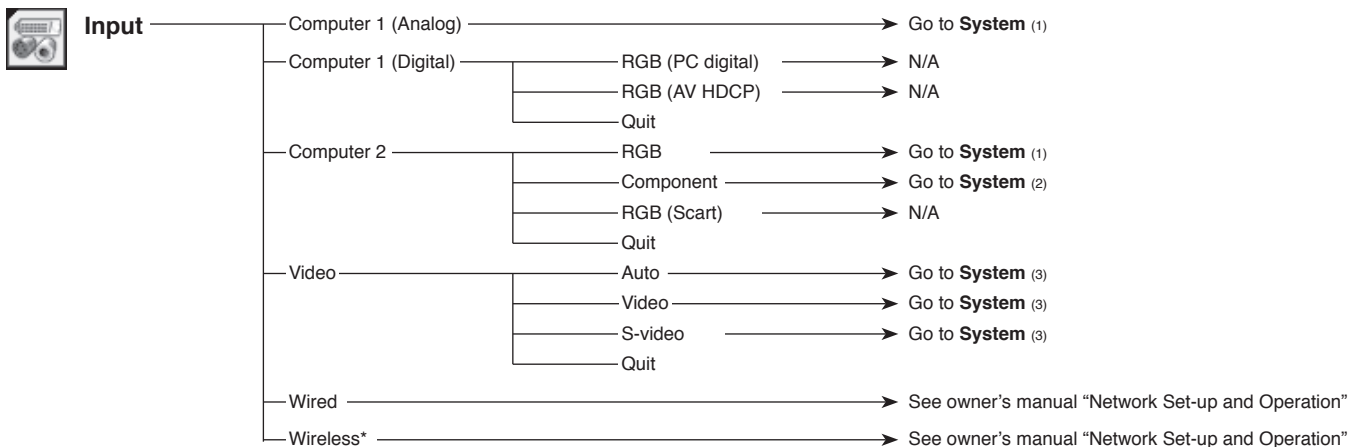

N/A..... not applicable

* The menu will be displayed when connecting device for the input source.

Sound

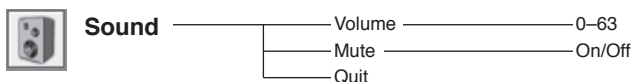

Computer Input

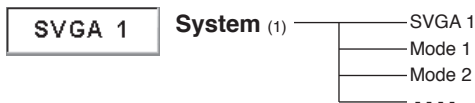

*Systems displayed in the System Menu vary depending on an input signal.

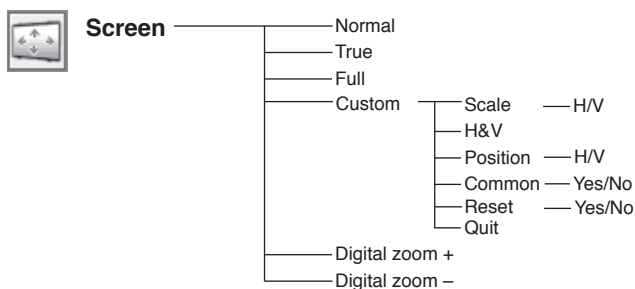
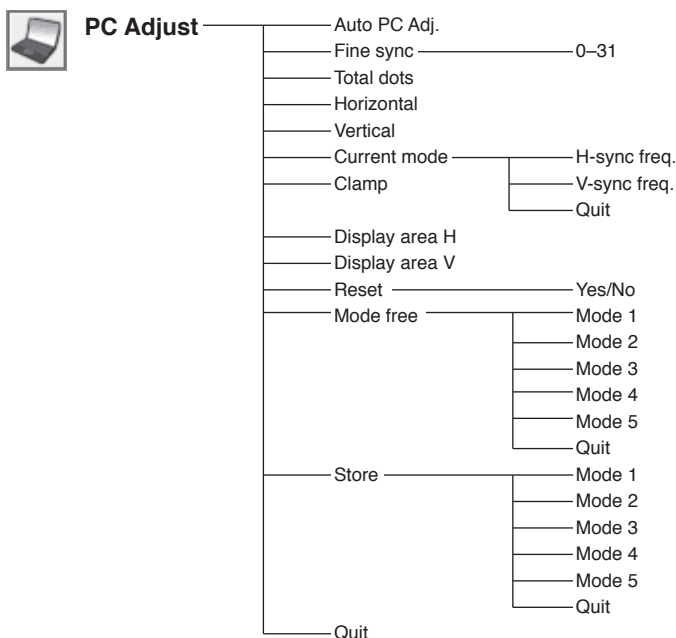
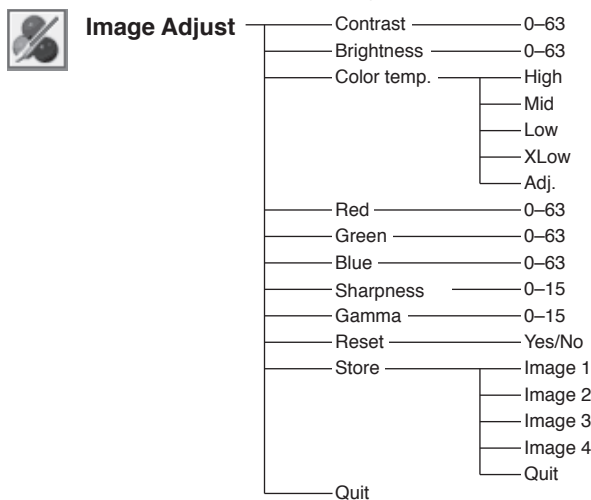
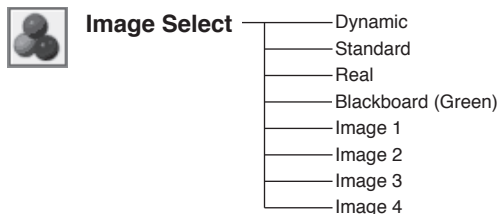

Video Input



System (2)

- Auto
- 1080i
- 1035i
- 720p
- 575p
- 480p
- 575i
- 480i



System (3)

- Auto
- PAL
- SECAM
- NTSC
- NTSC 4.43
- PAL-M
- PAL-N



Image Select

- Dynamic
- Standard
- Cinema
- Blackboard (Green)
- Image 1
- Image 2
- Image 3
- Image 4



Image Adjust

- Contrast — 0-63
- Brightness — 0-63
- Color — 0-63
- Tint — 0-63
- Color temp.
 - High
 - Mid
 - Low
 - XLow
 - Adj.
- Red — 0-63
- Green — 0-63
- Blue — 0-63
- Sharpness — 0-15
- Gamma — 0-15
- Noise reduction
 - Off
 - L1
 - L2
- Progressive
 - Off
 - L1
 - L2
 - Film
- Reset — Yes/No
- Store
 - Image 1
 - Image 2
 - Image 3
 - Image 4
 - Quit
- Quit



Screen

- Normal
- Zoom
- Natural wide
- Custom
 - Scale — H/V
 - H&V
 - Position — H/V
 - Common — Yes/No
 - Reset — Yes/No
 - Quit

Setting



























Setting

- Language — 16 languages provided.
- Quit
- Auto setup
 - Auto PC adj.
 - On/Off
 - Auto keystone
 - Auto
 - Manual
 - Off
- Keystone — Store/Reset
- Blue back — On/Off
- Display — On/Countdown off/Off
- Logo — Logo select
 - Off
 - Default
 - User
- Capture
 - Yes/No
- Logo PIN code lock
 - Off/On
 - Logo PIN code change
 - Quit
- Quit
- Ceiling — On/Off
- Rear — On/Off
- Input search — Off/On1/On2
- Standby mode — Eco/Normal
- Power management
 - Off
 - Ready
 - Shut down
 - Timer (1-30 Min.)
 - Quit
- On start — On/Off
- Lamp control — Normal/Auto/Eco
- Pointer
 - Spotlight/Pointer
 - Quit
- Remote control — Code 1-Code 8
- Security
 - Key lock
 - Off
 - Projector
 - Remote control
 - Quit
 - PIN code lock
 - Off/On1/On2
 - PIN code change
 - Quit
 - Alarm
 - Off
 - Battery charge — Off/Auto
 - Alarm volume — Small/Medium/Large
 - Sensitivity — Low/Medium/High
 - Ring time — 10 seconds/60 seconds/Long time
 - Quit
 - On
 - Quit
- Fan — L1/L2
- Fan control — Normal/Max
- Warning log
- Lamp counter
 - Hour(s)
 - Reset — Yes/No
 - Quit
- Filter counter
 - Hour(s)
 - Off/100H/200H/300H
 - Reset — Yes/No
 - Quit
- Factory default — Yes/No
- Quit

Indicators and Projector Condition

Check the indicators for projector condition.

For Alarm indicator, see page 58.

Indicators			Projector Condition
POWER red/green	WARNING red	LAMP REPLACE yellow	
			The projector is off. (The AC power cord is unplugged.)
			The projector is in stand-by mode. Press the POWER ON/STAND-BY button to turn on the projector.
			The projector is operating normally.
			The projector is preparing for stand-by or the projection lamp is being cooled down. The projector cannot be turned on until cooling is completed and the POWER indicator stops blinking.
			The projector is in the Power management mode.
			The temperature inside the projector is abnormally high. The projector cannot be turned on. When the projector is cooled down enough and the temperature returns to normal, the POWER indicator stops blinking and the projector can be turned on. (The WARNING indicator keeps blinking.) Check and clean the filter.
			The projector has been cooled down enough and the temperature returns to normal. When turning on the projector, the WARNING indicator stops blinking. Check and clean the air filter.
			The projector detects an abnormal condition and cannot be turned on. Unplug the AC power cord and plug it again to turn on the projector. If the projector is turned off again, unplug the AC power cord and contact the dealer or the service center for service and checkup. Do not leave the projector on. It may cause an electric shock or a fire hazard.

 ... green.

 ... red

 ... off

 ... blinks green.

 ... blinks red.

When the projection lamp reaches its end of life, the LAMP REPLACE indicator lights yellow. When this indicator lights yellow, replace the projection lamp with a new one promptly. Reset the lamp replacement counter after replacing the lamp. See pages 65-66.

Compatible Computer Specifications

Basically this projector can accept the signal from all computers with the V-, H-Frequency mentioned below and less than 140 MHz of Dot Clock for analog signal and 110 MHz of Dot Clock for digital signal.

When selecting these modes, PC adjustment can be limited.

ON-SCREEN DISPLAY	RESOLUTION	H-Freq. (KHz)	V-Freq. (Hz)	ON-SCREEN DISPLAY	RESOLUTION	H-Freq. (KHz)	V-Freq. (Hz)
VGA 1	640 x 480	31.47	59.88	SXGA 1	1152 x 864	64.20	70.40
VGA 2	720 x 400	31.47	70.09	SXGA 2	1280 x 1024	62.50	58.60
VGA 3	640 x 400	31.47	70.09	SXGA 3	1280 x 1024	63.90	60.00
VGA 4	640 x 480	37.86	74.38	SXGA 4	1280 x 1024	63.34	59.98
VGA 5	640 x 480	37.86	72.81	SXGA 5	1280 x 1024	63.74	60.01
VGA 6	640 x 480	37.50	75.00	SXGA 6	1280 x 1024	71.69	67.19
VGA 7	640 x 480	43.269	85.00	SXGA 7	1280 x 1024	81.13	76.107
MAC LC13	640 x 480	34.97	66.60	SXGA 8	1280 x 1024	63.98	60.02
MAC 13	640 x 480	35.00	66.67	SXGA 9	1280 x 1024	79.976	75.025
480p	640 x 480	31.47	59.88	SXGA 10	1280 x 960	60.00	60.00
575p	768 x 575	31.25	50.00	SXGA 11	1152 x 900	61.20	65.20
480i	—	15.734	^{60.00} (Interface)	SXGA 12	1152 x 900	71.40	75.60
575i	—	15.625	^{50.00} (Interface)	SXGA 13	1280 x 1024	50.00	^{86.00} (Interface)
SVGA 1	800 x 600	35.156	56.25	SXGA 14	1280 x 1024	50.00	^{94.00} (Interface)
SVGA 2	800 x 600	37.88	60.32	SXGA 15	1280 x 1024	63.37	60.01
SVGA 3	800 x 600	46.875	75.00	SXGA 16	1280 x 1024	76.97	72.00
SVGA 4	800 x 600	53.674	85.06	SXGA 17	1152 x 900	61.85	66.00
SVGA 5	800 x 600	48.08	72.19	SXGA 18	1280 x 1024	46.43	^{86.70} (Interface)
SVGA 6	800 x 600	37.90	61.03	SXGA 19	1280 x 1024	63.79	60.18
SVGA 7	800 x 600	34.50	55.38	SXGA 20	1280 x 1024	91.146	85.024
SVGA 8	800 x 600	38.00	60.51	SXGA+ 1	1400 x 1050	63.97	60.19
SVGA 9	800 x 600	38.60	60.31	SXGA+ 2	1400 x 1050	65.35	60.12
SVGA 10	800 x 600	32.70	51.09	SXGA+ 3	1400 x 1050	65.12	59.90
SVGA 11	800 x 600	38.00	60.51	MAC21	1152 x 870	68.68	75.06
MAC 16	832 x 624	49.72	74.55	MAC	1280 x 960	75.00	75.08
MAC 19	1024 x 768	60.24	75.08	MAC	1280 x 1024	80.00	75.08
XGA 1	1024 x 768	48.36	60.00	WXGA 1	1366 x 768	48.36	60.00
XGA 2	1024 x 768	68.677	84.997	WXGA 2	1360 x 768	47.70	60.00
XGA 3	1024 x 768	60.023	75.03	WXGA 3	1376 x 768	48.36	60.00
XGA 4	1024 x 768	56.476	70.07	WXGA 4	1360 x 768	56.16	72.00
XGA 5	1024 x 768	60.31	74.92	WXGA 6	1280 x 768	47.776	59.87
XGA 6	1024 x 768	48.50	60.02	WXGA 7	1280 x 768	60.289	74.893
XGA 7	1024 x 768	44.00	54.58	WXGA 8	1280 x 768	68.633	84.837
XGA 8	1024 x 768	63.48	79.35	WXGA 9	1280 x 800	49.60	60.05
XGA 9	1024 x 768	36.00	^{87.17} (Interface)	UXGA 1	1600 x 1200	75.00	60.00
XGA 10	1024 x 768	62.04	77.07	UXGA 2	1600 x 1200	81.25	65.00
XGA 11	1024 x 768	61.00	75.70	UXGA 3	1600 x 1200	87.5	70.00
XGA 12	1024 x 768	35.522	^{86.96} (Interface)	UXGA 4	1600 x 1200	93.75	75.00
XGA 13	1024 x 768	46.90	58.20	720p	1280 x 720	45.00	60.00
XGA 14	1024 x 768	47.00	58.30	720p	1280 x 720	37.50	50.00
XGA 15	1024 x 768	58.03	72.00	1035i	1920 x 1035	33.75	^{60.00} (Interface)
				1080i	1920 x 1080	33.75	^{60.00} (Interface)
				1080i	1920 x 1080	28.125	^{50.00} (Interface)

When the input signal is digital from DVI terminal, refer to the chart below.

ON-SCREEN DISPLAY	RESOLUTION	H-Freq. (KHz)	V-Freq. (Hz)	ON-SCREEN DISPLAY	RESOLUTION	H-Freq. (KHz)	V-Freq. (Hz)	
D-VGA	640 x 480	31.47	59.94	D-SXGA1	1280 x 1024	63.98	60.02	
D-480p	640 x 480	31.47	59.88	D-SXGA2	1280 x 1024	60.276	58.069	
D-575p	768 x 575	31.25	50.00	D-SXGA+1	1400 x 1050	63.97	60.19	
D-SVGA	800 x 600	37.879	60.32	D-720p	1280 x 720	37.50	50.00	D-720p50
D-XGA	1024 x 768	43.363	60.00	D-720p	1280 x 720	45.00	60.00	D-720p60
D-WXGA 1	1366 x 768	48.36	60.00	D-1035i	1920 x 1035	33.75	60.00 (Interlace)	
D-WXGA 2	1360 x 768	47.7	60.00	D-1080i	1920 x 1080	33.75	60.00 (Interlace)	D-1080i60
D-WXGA 3	1376 x 768	48.36	60.00	D-1080i	1920 x 1080	28.125	50.00 (Interlace)	D-1080i50
D-WXGA 4	1360 x 768	56.160	72.000					
D-WXGA 5	1366 x 768	46.500	50.000					
D-WXGA 6	1280 x 768	47.776	59.870					
D-WXGA 7	1280 x 768	60.289	74.893					
D-WXGA 9	1280 x 800	49.600	60.050					

✓Note:

- When the input signal is D-SXGA 1, D-SXGA 2, or D-SXGA+1, images may not be displayed properly depending on computers.
- The specifications are subject to change without notice.

Technical Specifications

Mechanical Information

Projector Type	Multi-media Projector
Dimensions (W x H x D)	334 mm x 78 mm x 257.5mm (Not including adjustable feet)
Net Weight	3.7 kg
Feet Adjustment	0° to 8.9°

Panel Resolution

LCD Panel System	0.74" TFT Active Matrix type, 3 panels
Panel Resolution	1,280 x 800 dots
Number of Pixels	3,072,000 (1,280 x 800 x 3 panels)

Signal Compatibility

Color System	PAL, SECAM, NTSC, NTSC4.43, PAL-M, and PAL-N
High Definition TV Signal	480i, 480p, 575i, 575p, 720p, 1035i, and 1080i
Scanning Frequency	H-sync. 15 kHz–100 kHz, V-sync. 50–100 Hz

Optical Information

Projection Image Size (Diagonal)	Adjustable from 40" to 300"
Throw Distance	3.3'(1.0 m) –39.7'(12.1m)
Projection Lens	F1.7–2.5 lens with f=19.2 mm–30.2 mm with manual zoom and focus
Projection Lamp	275 W

Interface

Video Input Jack	RCA Type x 1
S-video Input Jack	Mini DIN 4 pin x 1
Audio Input Jacks	RCA Type x 2
Computer Input 1/DVI-I Input Terminal	DVI-I Terminal X 1
Computer Input 2/Component Input Terminal	Mini D-sub 15 pin X 1
Monitor Output Terminal	Mini D-sub 15 pin x 1
Computer/Component Audio Input Jack	Mini Jack (stereo) x 1
Service Port Connector	Mini DIN 8 pin x 1
USB Connector	USB Series B connector x 1
Audio Output Jack	Mini Jack (stereo) x 1 (variable)
LAN Connection Terminal	100 Base-TX (100Mbps)/10 Base-T (10Mbps), RJ45
SD Card Slot	

Audio

Internal Audio Amp	1.0 W RMS
Built-in Speaker	1 speaker, ø28 mm

Power

Voltage and Power Consumption	AC 100–120 V (4.0A Max. Ampere), 50/60 Hz (The U.S.A and Canada) AC 200–240 V (2.0A Max. Ampere), 50/60 Hz (Continental Europe and The U.K.)
-------------------------------	---

Operating Environment

Operating Temperature	41°F–95°F (5 °C–35 °C)
Storage Temperature	14°F–140°F (-10°C–60 °C)

Remote Control

Battery	AAA or LR03 Type x 2
Operating Range	5 m/±30°
Dimensions	45 mm (W) x 23 mm (H) x 145 mm (D)
Net Weight	99 g (including batteries)
Laser Pointer	Class II Laser (Max. Output: 1 mW/Wave length: 640–660 nm)

Accessories

Owner's Manual
Quick Reference Guide
AC Power Cord
Remote Control and Batteries
VGA Cable
Lens Cover with String
PIN Code Label
Lamp Replacement Label
Alarm Label
Network Application (CD-ROM)
Soft Carrying Case

- The specifications are subject to change without notice.
- LCD panels are manufactured to the highest possible standards. Even though 99.99% of the pixels are effective, a tiny fraction of the pixels (0.01% or less) may be ineffective by the characteristics of the LCD panels.

Optional Parts

The parts listed below are optionally available. When ordering those parts, specify the item name and Model No. to the sales dealer.

	Model No.
COMPONENT~VGA Cable	: POA-CA-COMPVGA
SCART~VGA Cable	: POA-CA-SCART
VGA-Cable (10 m)	: KA-MC-DB10

PJ Link Notice

This projector is compliant with PJLink Standard Class 1 of JBMIA (Japan Business Machine and Information System Industries Association). This projector supports all commands defined by PJLink Class 1 and is verified conformance with PJLink Standard Class 1.

For PJ Link password, see page 49 on the owner's manual "Network Set-up and Operation."

Projector Input		PJLink Input	Parameter
Computer1 (Analog)		RGB 1	11
Computer1 (Digital)	RGB (PC digital)	DIGITAL 1	31
	RGB (AV HDCP)	DIGITAL 2	32
Computer2	RGB	RGB 2	12
	Component	RGB 3	13
	RGB (Scart)	RGB 4	14
Video	Auto	VIDEO 1	21
	Video	VIDEO 2	22
	S-video	VIDEO 3	23
Wired		NETWORK 1	51
Wireless		NETWORK 2	52
Memory viewer		STORAGE 1	41

PJLink is a registered trademark of JBMIA and pending trademark in some countries.



Configurations of Terminals

COMPUTER IN 2 /COMPONENT IN /MONITOR OUT (ANALOG)

Terminal: Analog RGB (Mini D-sub 15 pin)

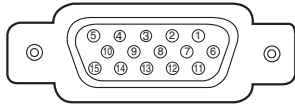

1	Red (R/Cr) Input/Output	9	+5V Power
2	Green (G/Y) Input/Output	10	Ground (Vert.sync.)
3	Blue (B/Cb) Input/Output	11	Ground
4	-----	12	DDC Data
5	Ground (Horiz.sync.)	13	Horiz. sync. Input/Output (Composite H/V sync.)
6	Ground (Red)	14	Vert. sync.
7	Ground (Green)	15	DDC Clock
8	Ground (Blue)		

DVI-I TERMINAL (DIGITAL/ANALOG)

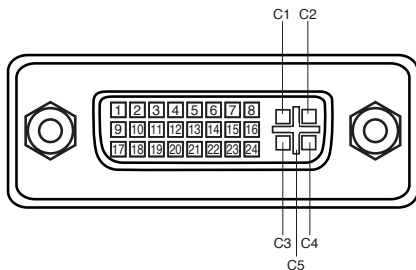

C1	Analog Red Input
C2	Analog Green Input
C3	Analog Blue Input
C4	Analog Horiz. sync
C5	Analog Ground (R/G/B)

1	T.M.D.S. Data2-	9	T.M.D.S. Data1-	17	T.M.D.S. Data0-
2	T.M.D.S. Data2+	10	T.M.D.S. Data1+	18	T.M.D.S. Data0+
3	T.M.D.S. Data2 Shield	11	T.M.D.S. Data1 Shield	19	T.M.D.S. Data0 Shield
4	No Connect	12	No Connect	20	No Connect
5	No Connect	13	No Connect	21	No Connect
6	DDC Clock	14	+5V Power	22	T.M.D.S. Clock Shield
7	DDC Data	15	Ground (for +5V)	23	T.M.D.S. Clock+
8	Analog Vert. sync	16	Hot Plug Detect	24	T.M.D.S. Clock-

USB CONNECTOR (Series B)

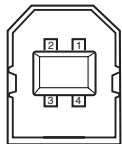

1	Vcc
2	- Data
3	+ Data
4	Ground

LAN TERMINAL

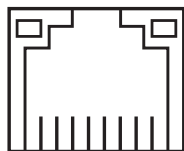

87654321

1	TX +	5	-----
2	TX -	6	RX -
3	RX +	7	-----
4	-----	8	-----

SERVICE PORT CONNECTOR

Terminal : Mini DIN 8-PIN

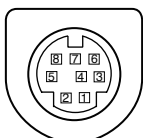

1	R X D	5	RTS/CTS
2	-----	6	T X D
3	-----	7	GND
4	GND	8	GND

PIN Code Number Memo

Write down the PIN code number in the column below and keep it with this manual securely. If you forgot or lost the number and unable to operate the projector, contact the service station.

PIN Code Lock No.	<input type="text"/> <input type="text"/> <input type="text"/> <input type="text"/>
	Factory default set No: 1 2 3 4*
Logo PIN Code Lock No.	<input type="text"/> <input type="text"/> <input type="text"/> <input type="text"/>
	Factory default set No: 4 3 2 1*
Alarm PIN Code No.	<input type="text"/> <input type="text"/> <input type="text"/> <input type="text"/>
	Factory default set No: 1 1 1 1*

*Should the four-digit number be changed, the factory set number will be invalid.

While the projector is locked with the PIN code.

Put the label below (supplied) on in a prominent place of the projector's body while it is locked with a PIN code.

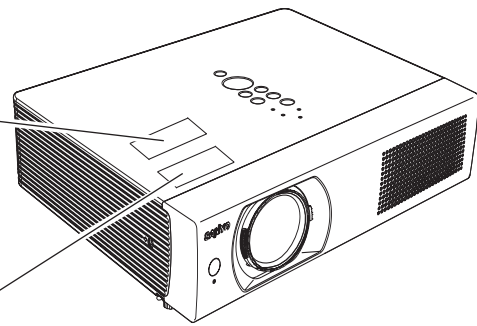

While the Antitheft alarm function is set....

Put the label below (supplied) on in a prominent place of the projector's body while the Antitheft alarm function is set.

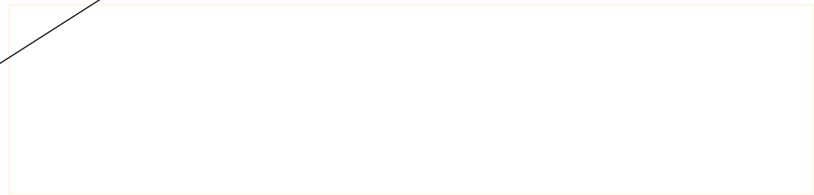

Lamp Replacement Label

When using the projector ceiling-mounted, put the Lamp replacement label (supplied) on in a prominent place of the projector's body to check the Replacement Lamp Type Number.

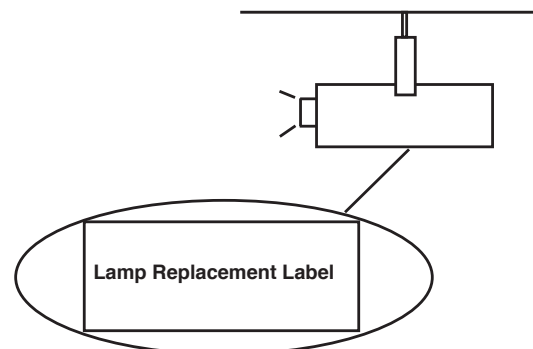

Dimensions

